

Garlock Expansion Joints

Technical Manual



Tube and Cover Materials

INTRODUCTION

Choosing an appropriate high quality premium elastomer for the media and environmental conditions is critical for the expansion joint to properly function and achieve maximum service life.

ABRASIVE APPLICATIONS

Proven to reduce wear and extend service life, the Garlock Expansion Joint Family of Abrasion Resistant Products were developed specifically for highly abrasive applications. Together, ABRA-LINE®, ABRA-SHIELD®, and natural rubber provide superior performance and exceptional quality in Power Generation, Fertilizer, Mining, Pulp and Paper, Wastewater, Marine and other markets.

ABRA-LINE®

Developed for highly abrasive applications, Garlock's proprietary, millable urethane formula was designed to be the most abrasion-resistant rubber liner available in an expansion joint. Third-party testing revealed that ABRA-LINE® expansion joints last 2-3 times longer than traditional elastomers because even the most aggressive media slides over the liner rather than digging in and removing material. Plus, the ABRA-LINE® liner's unique yellow color takes the guesswork out of visual evaluations. As the liner wears down, the yellow color darkens as the black backing becomes more prominent.

Temperature Range: -94°F (-70°C) to 180°F (80°C)

NOTE: Previously referred to as Style 404, 404HP, 404EPS, 404MAX, 406, 4394

NATURAL RUBBER

A common industry solution for basic abrasion resistance, natural rubber is often seen in a soft, tan, gum form. Natural Rubber from Garlock is black in color and features carbon black and other additives designed to improve its innate abrasion resistance and other, key physical properties.

Temperature Range: -75°F (-24°C) to 180°F (80°C)



ABRA-SHIELD®

Our proprietary hydrogenated nitrile butadiene rubber formula was specifically engineered for highly abrasive applications above the temperature limit of ABRA-LINE®. With over 50% better abrasion resistance than standard materials, ABRA-SHIELD® has proven high performance in diverse, aggressive applications with short or long term heat exposure up to 300°F (150°C). Unlike natural rubber, ABRA-SHIELD® has superior resistance to attack by petroleum oils, ozone, and UV.

Temperature Range: -83°F (-64°C) to 300°F (150°C)

ABRASION RESISTANCE

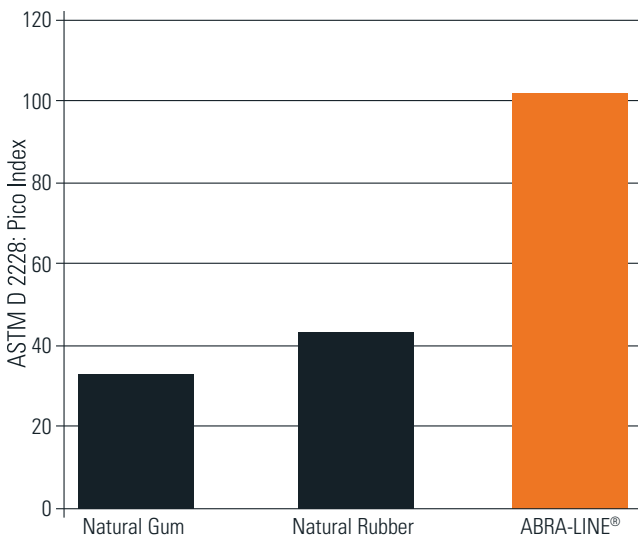

NOTE: 180°F and under material options and test method

ABRASION RESISTANCE

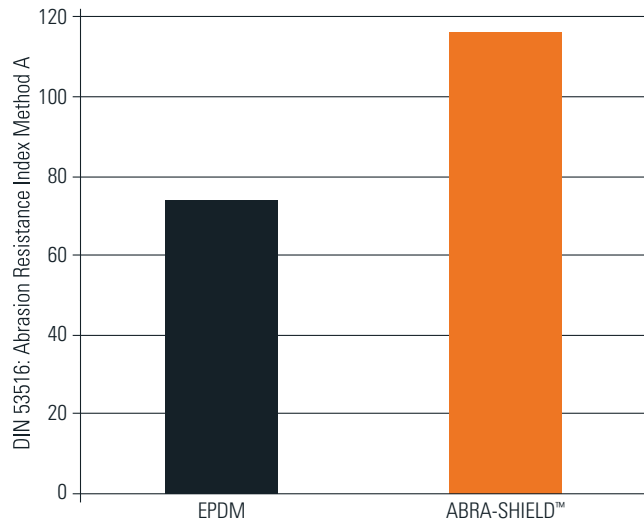

NOTE: 300°F and under material options and test method

Tube and Cover Materials

CHEMICAL APPLICATIONS

The Garlock family of chemically resistant products was developed with safety in mind. Our proprietary process for GUARDIAN® FEP mechanically bonded liners results in the industry's safest sealing solution for hazardous and dangerous chemicals. With Garlock, you'll have the peace of mind knowing that our materials are always 100% of the polymer specified. Garlock's team of engineers formulate all the compounds used, eliminating the chance for catastrophic failures due to the presence of an unknown, incompatible polymer's presence in a blended compound.

GUARDIAN® FEP LINER

A chemically resistant FEP liner that is mechanically bonded to the rubber expansion joint. This high-density FEP liner reduces permeation and offers optimal chemical resistance in applications up to 400°F. Only GUARDIAN® FEP Liners have no glue to be vulnerable to chemical attack. Comparable PTFE/FEP glue-in liners are highly susceptible to delamination and failure. GYLON® 3545 gaskets are also available with GUARDIAN® FEP liners to help achieve a seal with raised face flange connections, but a gasket is not required on flat face flanges.

Temperature Range: -100°F (-70°C) to 400°F (205°C)

FDA Compliant to 21CFR 177.1550

NOTE: Available only in 204, 204HP and 206 Product Families. Only available as the tube material. Previously referred to as Styles G200, G200HP, G306

FLUOROELASTOMERS (FKM)

Commonly referred to as VITON® or 3M FLUOREL®, Garlock's fluoroelastomer compound provides excellent chemical resistance in applications requiring the highest temperature rating available for rubber. Also considered the nearest thing to a universal elastomer, this specialty compound is also impervious to gasoline and UV/Ozone attack. Though it is not ideal for hot water, steam, polar solvents, low molecular weight esters and ethers, Garlock offers other options with higher fluorine content for improved temperature and chemical resistance.

Temperature Range: -10°F (-23°C) to 400°F (205°C)

HYPALON (CSM)

Optimal elastomer for applications which require diluted acid and ozone resistance within a moderate temperature range. Excellent compatibility with most chemicals, ideal for cover materials where resistance to weather and ultraviolet light is critical.

Temperature Range: -30°C (-34°C) to 250°F (120°C)

EPDM

Resistance to water absorption makes this elastomer the leading tube choice for water handling applications. Its outstanding UV/Ozone resistance also makes EPDM the first choice for cover materials in outdoor applications. In addition, EPDM also exhibits good performance in mild heat aging and acid systems.

Temperature Range: -67°F (-55°C) to 300°F (150°C)

NOTES:

* VITON is a registered trademark of Chemours Company

GENERAL SERVICE

CHLOROBUTYL

This unique elastomer possess a variety of important qualities that make it the expansion joint industry standard material. Chlorobutyl has exceptionally low permeability to gases, excellent vibration dampening properties, and good heat, chemical, ozone, and oxidation resistance.

Temperature Range: -40°F (-40°C) to 250°F (120°C)

NEOPRENE (CHLOROPRENE)

Commonly used as a cover material for expansion joints, neoprene possesses the fire retardant properties needed for compliance with ASTM F-1123. It is a high performing solution in harsh weather conditions, low temperatures, and general outdoor service. Neoprene is also available as a tube liner; creating a solution for a range of media including chemical, oil, grease and fuel.

Temperature Range: -25°F (-32°C) to 250°F (120°C)

OIL & GAS APPLICATIONS

Garlock expansion joints offer a variety of materials that are ideal for oil and gas applications. Service life, reliability, and environmental safety highlight the advantages of Garlock's oil and gas resistant elastomers. Garlock expansion joints are installed in marine engines, backup generators, and offshore loading around the world. These applications deliver critical services and demand the highest around the clock reliability.

HNBR

HNBR is the premier elastomer for use in oil and gas applications. On average, HNBR is 5X more resistant to oil and fuel than Nitrile with greater ozone, heat, and aging resistance.

Temperature Range: -83°F (-64°C) to 300°F (150°C)

NITRILE (BUNA-N)

Nitrile is considered an industry standard material due to its reliability in oil and gas applications. Nitrile can be used in a wide variety of applications.

Temperature Range: -30°F (-34°C) to 250°F (120°C)

Tube and Cover Materials

FOOD & POTABLE WATER APPLICATIONS (FDA 21CFR177.2600)

At Garlock, our commitment to providing safe products for use in food applications starts by mixing FDA compliant elastomers in-house. This allows for full control over the use of correct ingredients. Batch traceability is available and food safety is ensured with Current Good Manufacturing Practices. Compliance test reports and statements are available on www.garlock.com.

DETECTOMER® FDA NITRILE (BLUE)

Avoid foreign material contamination with metal and X-Ray detectable, FDA compliant, Nitrile elastomer, tested and validated by third party laboratories. Compatible for most animal fat and vegetable oil food products with good resistance to abrasion and water absorption. The blue color allows for additional contamination detection with automated vision and manual systems.

Temperature Range: -30°F (-34°C) to 250°F (120°C)

SURE-TEC™ FDA/NSF-61 EPDM (BLUE)

Assure technical compliance to the stringent requirements of both NSF/ANSI/CAN-61 for products used in potable drinking water as well as the food contact requirements with the industry's safest premium grade blue EPDM rubber design. SURE-TEC™ supplies exceptionally good abrasion and outstanding water absorption resistance as well as good resistance to many alkaline chemical services. Recommended for aqueous (water-based) food services, but not for fatty-type foods or milk. Outstanding weather and UV resistance.

Temperature Range: -40°F (-40°C) to 250°F (120°C)

NOTE: NSF/ANSI/CAN-61 compliance available only in 204, 206, and 7250 Product Families with SURE-TEC™ tube.

Reinforcing Materials

POLYESTER

Garlock features polyester fabric reinforcement in many of the expansion joint styles available. Coupled with metal body rings, the tightly woven fabric of polyester resists strand separation under pressure due to its high bidirectional strength.

Temperature Range: to +250°F (120°C)

NYLON TIRE CORD

Garlock also utilizes a high tensile strength tire cord for pressure reinforcement on a variety of styles. The biased tire cord reinforcement plies are applied to the expansion joint at a specific bias angle to obtain the best balance of pressure retention and resistance to swelling/strand separation.

Temperature Range: to +250°F (120°C)

NOTES:

* KEVLAR is a registered trademark of E.I. Dupont de Nemours & Co.

FDA EPDM (WHITE)

Premium grade white EPDM rubber with good resistance to many alkaline chemical services. Non-oil-resistant elastomer with very good abrasion and outstanding water absorption resistance. Recommended for aqueous (water-based) foods services, but not for fatty-type foods or milk. Outstanding weather and UV resistance.

Temperature Range: -67°F (-55°C) to 250°F (120°C)

FDA NEOPRENE (WHITE)

General purpose and off-white in color, FDA Neoprene is resistant to moderate chemicals, acids, oils, fats, grease, many solvents, and ozone.

Temperature Range: -25°F (-32°C) to 250°F (120°C)

DEIONIZED WATER EXTRACTABLES PER FDA CFR-2100-177.2600

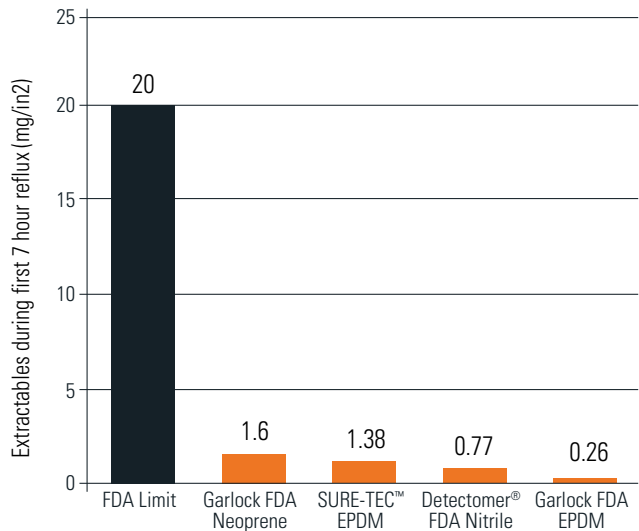

KEVLAR® TIRE CORD

Garlock makes use of high strength KEVLAR® Tire Cord as an alternative material for elevated temperature service. Styles using KEVLAR® Tire Cord can achieve a maximum of 300°F without impacting pressure rating.

Temperature Range: to +300°F (150°C)

FIBERGLASS/KEVLAR

Fiberglass/KEVLAR is utilized in Garlock expansion joints for maximum temperature service. Designed for flue gas or exhaust systems, this fabric offers high durability and pressure retention in extreme temperature applications.

Temperature Range: to +400°F (+205°C)

Typical Properties of Elastomers

Material Designation		Rating Scale Code	Elastomer Physical and Chemical Properties Comparison																															
ANSI / ASTM D1418-77	ASTM D-2000 D1418-77	7 - Outstanding 3 - Fair to Good	Water	Chemical	Animal & Vegetable Oil	Alkali, Condensed	Alkali, Dilute	Oil & Gasoline	Lacquers	Oxygenated Hydrocarbons	Aromatic Hydrocarbons	Aliphatic Hydrocarbons	Acid, Concentrated	Acid, Dilute	Swelling in Oil	Radiation	Water Absorption	Electric Insulation	Dielectric Strength	Tensile Strength	Compression Set	Rebound, Cold	Rebound, Hot	Dynamic	Impermeability	Abrasion	Tear	Flame	Cold	Heat	Oxidation	Sunlight	Weather	Ozone
		6 - Excellent 2 - Fair																																
		5 - Very Good 1 - Poor to Fair																																
		4 - Good 0 - Poor																																
		4* - good @ room temp, poor above 180°F (80°C)																																
		X - Contact manufacturer																																
		COMMON NAME																																
		Chemical Group Name																																
CR	BC BE	NEOPRENE chloroprene	4	3	4	0	4	4	0	1	2	3	4	6	4	5	4	3	5	4	2	4	5	2	4	5	4	4	4	4	5	5	6	5
NR	AA	NATURAL RUBBER polyisoprene, synthetic	5	3	X	X	X	0	0	4	0	0	3	3	0	6	5	5	6	6	4	6	6	6	2	7	5	0	5	2	4	0	2	0
CIIR	AA BA	CHLOROBUTYL chloro-isobutene-isoprene	5	6	5	4	4	0	3	4	0	0	4	6	0	4	5	5	5	4	3	0	5	2	6	4	4	0	4	5	6	5	5	6
NBR	BE BK CH	BUNA-N / NITRILE nitrile-butadiene	4	3	5	0	4	5	2	0	4	6	4	4	5	5	4	1	0	5	5	4	4	5	4	4	3	0	3	4	4	0	2	2
HNBR	DH	HNBR hydrogenated-nitrile-butadiene	4	3	5	0	4	6	2	0	4	6	4	4	6	5	4	1	0	5	6	4	4	5	4	7	6	0	3	6	4	0	2	2
CSM	CE	HYPALON chloro-sulfonyl-polyethylene	5	6	4	4	4	4	3	1	2	3	4	6	4	5	4	3	5	2	2	2	4	2	4	4	3	4	4	4	6	7	6	7
FKM	HK	VITON* / FLUOREL** fluorocarbon elastomer	5	6	6	0	4	6	1	0	6	6	6	5	6	5	5	3	5	5	6	2	4	5	5	5	2	6	2	7	7	7	7	7
EPDM	BA CA DA	EPDM ethylene-propylene-diene-terpolymer	5	6	5	6	6	0	3	6	0	0	4	6	0	7	6	6	7	5	4	6	6	5	4	5	4	0	5	6	6	7	6	7
AFMU		TEFLON* / TFE / FEP fluoro-ethylene-polymers	7	7	7	7	7	7	7	7	7	7	7	7	7	3	7	X	X	X	X	X	X	X	X	4	X	X	X	7	7	7	7	7
AU	AA BA	POLYURETHANE	4*	3	5	0	1	5	1	2	3	6	0	1	6	6	4*	3	5	7	3	3	4	6	4	7	6	2	6	4	5	4	6	6

* Viton and Teflon are registered trademarks of The Chemours Co.

** Fluorel is a registered trademark of 3M Companies.

Kevlar is a registered trademarks of E.I. DuPont de Nemours & Co.

Style 204 Narrow Arch

The Style 204 family of spool-type expansion joints is manufactured with the industry standard narrow arch design. This style is intended to be used in dynamic conditions where both pressure and vacuum concerns are present.

BENEFITS

- » Fully laboratory and field tested for long life and exceptional reliability.
- » High pressure and vacuum resistance offer increased safety and ensure suitability for a wide range of applications.
- » Single and multi-arch designs are available for a range of movement capabilities.
- » Concentric and eccentric reducing configurations can be provided to join piping of unequal diameters.
- » Available in a variety of elastomer and fabric combinations to meet the varied demands of temperature, pressure, and media.

PRESSURE RATING

PIPE I.D.		204		204HP		204EPS		204MAX	
inch	mm	psi	bar	psi	bar	psi	bar	psi	bar
1/2-4	13-100	165	11.4	200	13.8	250	17.2	360	24.8
5-8	125-200	140	9.7	190	13.1	250	17.2	360	24.8
10	250	140	9.7	190	13.1	250	17.2	325	22.4
12	300	140	9.7	190	13.1	250	17.2	300	20.7
14	350	85	5.9	130	9.0	150	10.3	300	20.7
16-20	400-500	65	4.5	110	7.6	150	10.3	300	20.7
22-24	550-600	65	4.5	100	6.9	150	10.3	300	20.7
26-40	650-1000	55	3.8	90	6.2	100	6.9		
42-66	1050-1650	55	3.8	80	5.5	100	6.9		
68-96	1700-2400	45	3.1	70	4.8	100	6.9		
98-108	2450-2700	40	2.8	60	4.1	80	5.5		
110-120	2750-3000	30	2.1	50	3.4	80	5.5		

VACUUM RATING - 29.9 In. Hg (750mm Hg.)

- » Full vacuum rating for all sizes and face to face
- » Style 204EVS available for continuous full vacuum service

TEMPERATURE - UP TO 400°F (205°C)

- » Max temperature is based on the lowest temperature of the material selected.

CERTIFICATIONS

- » CRN's all provinces - 204HP (1/2" - 96" ID)
- » 1OCFR50 Appendix B - 204, 204HP, 204EPS
- » ABS Type Approval - 204HP (1/2" - 96" ID) & 204MAX (2" - 24" ID)
- » ASTM F-1123 Compliant - 204HP, 204MAX on request



Visit Garlock.com for our 3D model generation tool

STANDARD DESIGN

» Tube

- › Chlorobutyl resists cracking due to high temperatures, weathering, oxidation and chemicals
- › Abrupt arch configuration provides maximum movement, and pressure and vacuum resistance
- › Seamless tube creates a positive flange seal without gaskets

» Body

- › Chlorobutyl/polyester construction with welded, treated metal body rings for dimensional stability

» Cover

- › A homogeneous layer of chlorobutyl fully extends to the outside edge of the flange.
- › A durable exterior coating further protects the expansion joint from the effects of weathering and oxidation.

» Flanges

- › The seamless flange face eliminates the need for separate gaskets to facilitate installation in flat face flanges.
- › Multiple flange configurations available:
 - ASME B16.5/B16.47 Series A Class 125/150 (standard)
 - ASME B16.5/B16.47 Series A Class 250/300
 - EN 1092-1 PN10
 - EN 1092-1 PN16
 - Other configurations available upon request

MATERIALS OF CONSTRUCTION

See pages 4 - 6 for tube and cover material options.

Style 204 Narrow Arch

MOVEMENT CAPABILITIES

NOMINAL ID		COMPRESSION		ELONGATION		LATERAL	
		inch	mm	inch	mm	inch	mm
1/2-1-1/2	13-40	0.25	6	0.125	3	0.25	6
2-6	50-150	0.5	13	0.25	6	0.5	13
8-18	200-450	0.75	19	0.375	10	0.5	13
20-24	500-600	0.875	22	0.4375	11	0.5	13
26-40	650-1000	1	25	0.5	13	0.5	13
42-120	1050-3000	1.125	29	0.5	13	0.5	13

NOTES:

- Movements listed are per arch. Movements are reduced by half for filled arches. Movements listed are non concurrent. For concurrent movements, contact Garlock.
- Pipe sizes through 1½" are supplied with a filled arch, and movements have been reduced accordingly.

STANDARD FACE TO FACE

NOMINAL ID		1 ARCH		2 ARCH		3 ARCH		4 ARCH	
inch	mm	inch	mm	inch	mm	inch	mm	inch	mm
1/2-8	13-200	6	150	10	250	14	350	18	450
10-20	250-500	8	200	12	300	16	400	20	500
22-40	550-1000	10	250	14	350	18	450	22	550
42-120	1050-3000	12	300	16	400	20	500	24	600

NOTES:

- Multiple arches not available with GUARDIAN® FEP Liners, or Reducing Expansion Joints
- For shorter "FF" dimensions, consult Garlock

OPTIONAL CONFIGURATIONS

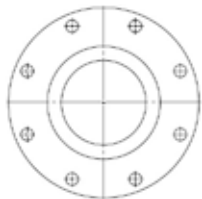

Concentric Reducing

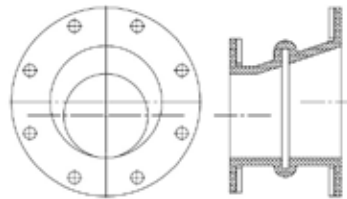

Eccentric Reducing

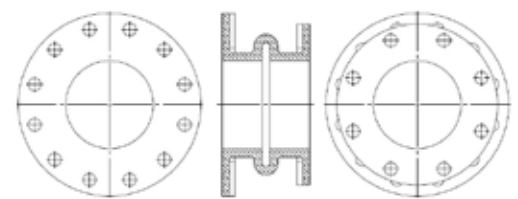

Unique Drill Patterns per flange

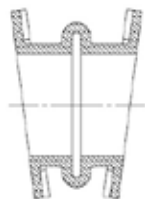

Angular Offset



Lateral Offset

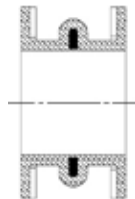

Filled Arches

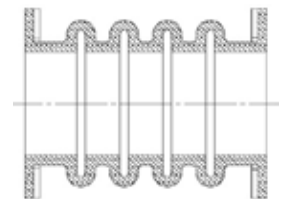

Multiple Arches

NOTES:

- GUARDIAN® FEP Liners not available with all options. For specific inquires contact Garlock.

Style 206 EZ-FLO®

The Style 206 EZ-FLO family of expansion joints is constructed with a single, wide, flowing arch. It is intended for use in dynamic, high-pressure applications where low spring rates and a self-flushing arch are required.

BENEFITS

- » Self-flushing design eliminates media buildup and reduces fluid turbulence
- » High pressure ensures longer life and reduces inventory requirements
- » Lightweight design installs easily

STANDARD DESIGN

» Tube

- › Chlorobutyl resists cracking due to high temperatures, weathering, oxidation and chemicals
- › Flowing arch design adds pressure resistance and reduces product buildup

» Body

- › The rubber reinforced nylon tire cord and polyester construction provide flexibility as well as durability.

» Cover

- › A homogeneous layer of chlorobutyl fully extends to the outside edge of the flange.
- › A durable exterior coating further protects the expansion joint from the effects of weathering and oxidation.

» Flanges

- › The seamless flange face eliminates the need for separate gaskets to facilitate installation in flat face flanges.
- › Multiple flange configurations available:
 - ASME B16.5/B16.47 Series A Class 125/150 (standard)
 - ASME B16.5/B16.47 Series A Class 250/300
 - EN 1092-1 PN10
 - EN 1092-1 PN16
 - Other configurations available upon request

MATERIALS OF CONSTRUCTION

See pages 4 - 6 for tube and cover material options.

TEMPERATURE - UP TO 300°F (150°C)

- » Max temperature is based on the lowest temperature of the material selected.



Visit Garlock.com for our 3D model generation tool

PRESSURE & VACUUM RATING

PIPE I.D.		STANDARD FACE TO FACE		PRESSURE		VACUUM	
Inch	mm	Inch	mm	psi	bar	in. Hg	mm Hg
1-8	25-200	6	150	250	17.2	26	650
10	250	8	200	250	17.2	26	650
12	300	8	200	250	17.2	12	300
14	350	8	200	130	9	12	300
16-20	400-500	8	200	110	7.6	12	300
22-24	550-600	10	250	100	6.9	12	300
26-40	650-1000	10	250	90	6.2	12	300
42-66	1050-1650	12	300	80	5.5	12	300
68-96	1700-2400	12	300	70	4.8	12	300
98-108	2450-2700	12	300	60	4.1	12	300
110-120	2750-3000	12	300	50	3.4	12	300

* Pressure and vacuum ratings at neutral FF dimension. Extended face to face dimensions result in reduced pressure and vacuum ratings for Style 206 EZ-FLO® expansion joints.

CERTIFICATIONS AND COMPLIANCE

- » ABS Type Approved (2" - 48" ID)
- » ISO 15540 Fire Safe***
- » 10CFR50 Appendix B
- » ASTM F-1123 compliant
- » 46CFR56 (USCG)
- » CRN - All provinces (2" - 48" ID)

*** Requires use of fire safe cover

Style 206 EZ-FLO®

MOVEMENT CAPABILITIES

NOMINAL ID		COMPRESSION		ELONGATION		LATERAL	
		inch	mm	inch	mm	inch	mm
1-5	25-125	0.75	19	0.375	10	0.5	13
6-18	150-450	1	25	0.5	13	0.5	13
20-24	500-600	1.125	29	0.5	13	0.5	13
26-40	650-1000	1.25	32	0.5	13	0.5	13
42-120	1050-3000	1.375	35	0.5	13	0.5	13

NOTES: Movements are reduced by half with GUARDIAN® FEP liners. Movements listed are non-concurrent. For concurrent movements, contact Garlock.

OPTIONAL CONFIGURATIONS

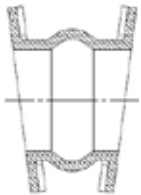

Angular Offset

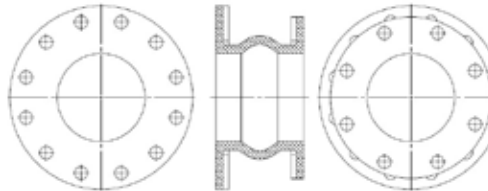

Unique Drill Patterns per flange



Lateral Offset

SURE-LINK™

These PTFE concentric spool-type flexible couplings are designed to reduce noise and compensate for expansion, contraction and minor piping misalignment in chemical processing, air conditioning and heating systems.

STYLE 214 - COUPLINGS

- » Two convolutions
- » Temperature: -100°F (-70°C) to +450°F (+230°C)
- » Pressure: To 178 psig (12 bar),
Full vacuum to +350°F (+180°C)

STYLE 215 - EXPANSION JOINTS

- » Three convolutions
- » Temperature: -100°F (-70°C) to +450°F (+230°C)
- » Pressure: To 132 psig (9 bar),
Full vacuum to +180°F (+80°C)

STYLE 216 & 217 - BELLOWS

- » Four or Five convolutions
- » Temperature: -100°F (-70°C) to +450°F (+230°C)
- » Pressure: To 87 psig (6 bar),
Vacuum to 17.7 In. Hg (0.6 bar) at 32°F (0°C)
to No Vacuum at 212°F (100°C)

BENEFITS

- » The convolution shape provides extra-long flex life at high temperatures
- » The proprietary contour molding process ensures consistent wall thickness for improved blowout resistance
- » PTFE body withstands corrosion, water, steam, and most chemicals and gases
- » Preset tie rods prevent over-extension
- » FDA Compliant to 21CFR177.1550
- » Available silicone-free upon request

PTFE CONTROL UNITS AND FLANGES

All PTFE joints and couplings are furnished with metallic flanges and tie rods/control units ready for immediate installation on the job site. Flanges in other alloys are available by special order.

Flanges are protected to resist atmosphere corrosion and are tapped to ASME B16.5/B16.47 Series A Class 125/150 (standard).

Control units are assembled with flanges to prevent joints from excessive axial elongation. They are designed to accept the static pressure thrust in the piping system.

Tie rods are factory set to maximum face-to-face working limits, with lock nuts as insurance against over-extension of the expansion joint. The polyethylene covered tie rods eliminate metal to metal contact between the rods and the flanges; the most frequent cause of noise transmission and electrolysis.

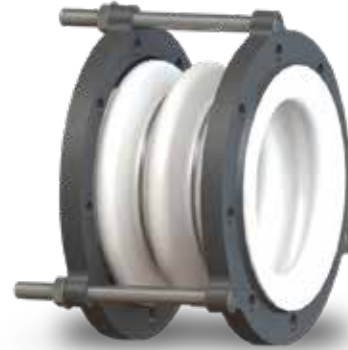

STANDARD DESIGN

- » Complete assembly includes
 - › Fluorocarbon resin PTFE body
 - › Corrosion resistant plated metallic flanges
 - › Polyethylene-covered zinc plated restriction bolts
 - › Stainless steel corrosion-resistant reinforcing rings
- » Standard sizes from 1" (25mm) through 24" (800mm) pipe I.D.
- » Available with 304 or 316 stainless steel flanges and tie rods upon request

PRESSURE RATING

Garlock PTFE expansion joints and couplings have pressure ratings high enough to handle most applications. As the pipe size gets larger, Garlock increases the bellows thickness and the strength of the reinforcing rings to compensate for the change in internal forces. This permits the same high pressure rating for all sizes.

Temp. °F (°C)	SURE-LINK™	SURE-LINK™	SURE-LINK™	SURE-LINK™
	2 Conv. Pressure psi (bar)	3 Conv. Pressure psi (bar)	4 Conv. Pressure psi (bar)	5 Conv. Pressure psi (bar)
50 (10)	178 (12)	132 (9)	87 (6)	87 (6)
100 (50)	165 (11)	120 (8)	87 (6)	87 (6)
150 (65)	150 (10)	103 (7)	81 (5.5)	81 (5.5)
200 (90)	130 (9)	90 (6)	71 (5)	71 (5)
250 (120)	110 (8)	75 (5)	59 (4)	59 (4)
300 (150)	92 (6)	60 (4)	48 (4)	48 (4)
350 (180)	78 (5)	50 (3)	36 (2.5)	36 (2.5)
400 (205)	65 (4.5)	42 (3)	28 (2)	28 (2)
450 (230)	60 (4)	35 (2.5)	17 (1)	17 (1)

SURE-LINK™

MOVEMENT CAPABILITIES

Nominal I.D. Inch (mm)	SURE-LINK™ Maximum Axial Movement, + or -				SURE-LINK™ Maximum Lateral Deflection, + or -			
	2 Convolutions	3 Convolutions	4 Convolutions	5 Convolutions	2 Convolutions	3 Convolutions	4 Convolutions	5 Convolutions
1 (25)	1/4	1/2	11/16	7/8	1/8	1/4	1/2	9/16
1.25 (32)	3/8	9/16	11/16	7/8	1/4	3/8	1/2	9/16
1.5 (40)	1/4	1/2	13/16	1	1/8	1/4	9/16	11/16
2 (50)	1/4	3/4	13/16	1	1/8	3/8	9/16	11/16
2.5 (65)	5/16	3/4	7/8	1 1/16	1/8	3/8	5/8	13/16
3 (80)	3/8	1	7/8	1 1/16	3/16	1/2	5/8	13/16
4 (100)	1/2	1	15/16	1 3/16	1/4	1/2	11/16	7/8
5 (125)	1/2	1	1	1 1/4	1/4	1/2	11/16	7/8
6 (150)	1/2	1 1/8	1 1/8	1 3/8	1/4	9/16	11/16	7/8
8 (200)	1/2	1 1/8	1 3/16	1 1/2	1/4	9/16	13/16	1
10 (250)	5/8	15/16	1 1/4	1 9/16	3/8	9/16	13/16	1
12 (300)	5/8	15/16	1 1/4	1 9/16	3/8	9/16	13/16	1
14 (350)	21/32	1	1 5/16	1 11/16	3/8	9/16	13/16	1
16 (400)	21/32	1	1 5/16	1 11/16	3/8	9/16	13/16	1
18 (450)	21/32	1	1 5/16	1 11/16	3/8	9/16	13/16	1
20 (500)	11/16	1 1/16	1 7/16	1 3/4	13/32	5/8	7/8	1 1/16
24 (600)	11/16	1 1/16	1 7/16	1 3/4	13/32	5/8	7/8	1 1/16

FLANGE DIMENSIONS AND DRILLING

Nominal Pipe Size I.D. (Inch)	Flange Dimensions		
	Outside Diameter	Thickness	Bolt Hole Threads
1	5-13/16	3/8	1/2-13
1.25	7-5/16	9/16	1/2-12
1.5	6-11/16	3/8	1/2-13
2	7-7/16	1/2	5/8-11
2.5	8-7/16	5/6	5/8-11
3	9-3/16	5/8	5/8-11
4	10-11/16	11/16	5/8-11
5	11-11/16	11/16	3/4-10
6	13-1/4	11/16	3/4-10
8	15-3/4	11/16	3/4-10
10	18-1/8	13/16	7/8-9
12	20-1/2	13/16	7/8-9
14	23-1/16	13/16	1-8
16	25-1/16	15/16	1-8
18	27-9/16	1-1/16	1 1/8-7
20	30-7/8	1-1/16	1 1/8-7
24	35-7/16	1-1/8	1 1/8-7

STANDARD FACE TO FACE

Nominal Pipe Size I.D. (Inch)	SURE-LINK™ 2 Conv.	SURE-LINK™ 3 Conv.	SURE-LINK™ 4 Conv.	SURE-LINK™ 5 Conv.	Torque Values ft.-lbs.
	Install Length	Install Length	Install Length	Install Length	
1	1.375	1.750	2.625	3.125	15
1.25	2.000	2.625	3.188	3.750	15
1.5	1.375	2.000	3.313	3.938	15
2	1.563	2.750	3.375	4.000	20
2.5	2.250	3.188	4.000	4.813	25
3	2.250	3.625	4.438	5.375	30
4	2.625	3.625	4.625	5.625	35
5	3.250	4.000	4.938	5.938	40
6	2.750	4.000	5.125	6.125	44
8	4.000	6.000	5.250	6.313	50
10	3.063	4.250	5.375	6.563	55
12	3.125	4.313	5.500	6.688	60
14	3.563	4.813	6.063	7.313	70
16	3.688	4.938	6.188	7.438	75
18	4.125	5.438	6.750	8.125	80
20	4.125	5.438	6.750	8.125	85
24	4.125	5.500	6.813	8.125	90

GARFLEX® Style 8100

GARFLEX® expansion joints feature rugged yet flexible nylon tire cord reinforcement in a molded, spherical bellows design that ensures exceptional burst pressure ratings. The streamlined flowing arch design reduces turbulence and allows smooth, quiet flow without the restricted movement you'll find with a filled arch design.

BENEFITS

- » Flowing arch design prevents sediment buildup and reduces turbulence .
- » The nylon reinforcement provides the support needed for higher pressure applications without sacrificing flexibility.
- » Floating flanges can be rotated to accommodate torsional misalignment .
- » Can be installed against flat or raised face pipe flanges without the need for gaskets or spacers.

STANDARD DESIGN

- » Tube
 - › Seamless tube creates a positive flange seal without gaskets.
- » Cover
 - › The homogeneous layer of rubber can withstand the rigors of weathering and ozone.
- » Flanges
 - › Rotating metallic flanges with zinc plating for corrosion-resistance.
 - › Multiple flange configurations available:
 - › ASME B16.5/B16.47 Series A Class 125/150 (standard)
 - › ASME B16.5/B16.47 Series A Class 250/300
 - › EN 1092-1 PN10
 - › EN 1092-1 PN16



MATERIALS OF CONSTRUCTION

- » Yellow Band – Nitrile Tube with Neoprene Cover
- » Red Band – EPDM Tube with EPDM Cover

TEMPERATURE / PRESSURE RATING

OPERATING TEMPERATURE		PRESSURE CLASS			
		10		16	
°F	°C	psi	bar	psi	bar
up to 122°	up to 50°	145	10	232	16
123° - 158°	50° - 70°	116	8	174	12
159° - 212°	70° - 100°	87	6	145	10

BELLOW SIZES

Nominal I.D. Inch (mm)	Nominal F-F		
	5" (130mm)	6" (150mm)	8" (200mm)
1 (25)	16	NA	NA
1.25 (32)	16	NA	NA
1.5 (40)	16	NA	NA
2 (50)	16	16	NA
2.5 (65)	16	16	NA
3 (80)	16	16	NA
4 (100)	16	16	NA
5 (125)	16	16	NA
6 (150)	16	16	NA
8 (200)	16	16	NA
10 (250)	16	NA	10
12 (300)	16	NA	10
14 (350)	NA	NA	16
16 (400)	NA	NA	16
18 (450)	NA	NA	10
20 (500)	NA	NA	10
24 (600)	NA	NA	10

GARFLEX® Style 8100

CERTIFICATIONS AND COMPLIANCE

Yellow Band – Nitrile Tube with Neoprene Cover

- » ABS Type Approved (2" - 12" ID)
- » ISO 15540 Fire Safe (Requires use of fire safe cover)
- » ASTM F-1123 Compliant
- » 46CFR56 (USCG)

VACUUM RATING*

PIPE I.D.		VACUUM	
Inch	mm	in. Hg	mm Hg
1 - 2	25 - 50	29.9	750
2-1/2	65	20.7	525
3	80	17.7	450
4	100	11.8	300
5 - 8	125 - 200	8.9	225
10	250	5.9	150
12	300	3.0	75
14 - 24	350 - 600	Not Recommended	

* At nominal FF dimensions only.

MOVEMENT CAPABILITIES

Nominal I.D.		Nominal Face to Face		MOVEMENT TYPE						
				Compression		Elongation		Lateral		Angular
inch	mm	inch	mm	inch	mm	inch	mm	inch	mm	deg.
1 - 3	25 - 80	5	130	1-3/16	30	13/16	20	1-3/16	30	30
4 - 6	100 - 150	5	130	1-3/16	30	13/16	20	1-3/16	30	20
8	200	5	130	1	25	1-3/16	30	1-3/16	30	10
10 - 12	250 - 300	5	130	9/16	15	1-3/16	30	9/16	15	5
2 - 8	50 - 200	6	150	1-3/8	35	1-3/16	30	1-3/16	30	15
10 - 12	250 - 300	8	200	1-9/16	40	1-3/8	35	1-3/16	30	10
14 - 24	350 - 600	8	200	1-9/16	40	1-3/8	35	1-3/16	30	8

Style 7250 FLEXO-MATIC™

The 7250 FLEXO-MATIC™ is designed to absorb noise and vibration in air-conditioning, heating, and industrial piping systems.

BENEFITS

- » Eliminating noise at its source, Garlock FLEXO-MATIC™ rubber connectors are designed to absorb equipment noise before it is transmitted through piping systems.
- » Because high-frequency vibrations are virtually eliminated, the FLEXO-MATIC™ helps extend equipment life.
- » Expansion, contraction, and misalignment are all compensated for with FLEXO-MATIC™ connectors.
- » The FLEXO-MATIC™ absorbs water hammer (vibration of the fluid media itself) as well as compensates for expansion, contraction, and misalignment.
- » No risk of electrolytic corrosion since there is no metal-to-metal contact between the connectors and metal piping.

STANDARD DESIGN

- » **Tube**
 - › A protective, leakproof lining made of a synthetic rubber which may vary depending on the service.
- » **Body**
 - › Fabric Reinforcement—Polyester, or other suitable fabrics impregnated with an elastomer are wrapped and plied to provide the flexibility and support required between the tube and cover.
 - › Metal Reinforcement—Helical-wound steel reinforcement wire is firmly embedded in the body to provide resistance to both vacuum and pressure.
- » **Cover**
 - › A homogeneous layer of synthetic rubber to protect the body from corrosive attack or mechanical damage, the rugged cover withstands aging and weathering for a long, trouble-free life.
- » **Flanges**
 - › Seamless flange face eliminates need for gaskets
 - › Standard flange (ASME B16.5/B16.47 Class 125/150 Series A)
 - › Also available in;
 - ASME B16.5/B16.47 Class 250/300 Series A
 - EN 1092-1 PN10
 - EN 1092-1 PN16
 - › Contact Garlock for all others

TEMPERATURE - UP TO 400°F (205°C)

- » Max temperature is based on the lowest temperature of the material selected.



STANDARD SIZES

PIPE I.D.		RECOMMENDED LENGTH	
inch	mm	inch	mm
0 - 2.5	0 - 65	12	305
3 - 4	75 - 100	18	457
5 - 24	125 - 600	24	610

PRESSURE & VACUUM RATING

PIPE I.D.		PRESSURE		VACUUM	
inch	mm	psi	bar	in. Hg	mm Hg
2 - 16	50 - 400	150	10.3	29.9	750
18 - 24	450 - 600	100	6.9	29.9	750

MATERIALS OF CONSTRUCTION

See pages 4 - 6 for tube and cover material options.

OPTIONAL CONFIGURATIONS

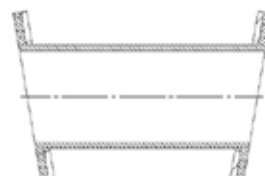

Angular Offset



Lateral Offset



Unique Drill Patterns per flange

Style 9394

This multi-convolute, lightweight expansion joint is designed for lower pressure applications that require significant amounts of movement, axially and/or laterally. With low spring rates, it is ideal for load cell applications as well.

BENEFITS

- » The lightweight design installs easily and carries the added bonus of reduced shipping costs when compared to higher pressure designs.
- » Custom designs available for applications requiring greater than published movement ratings.
- » A variety of construction materials are available for a wide range of temperature needs.
- » Available in flanged or sleeve type design, up to 48" max. (1,219 mm) I.D. *Contact Garlock for larger ID sizes
- » Flanges
 - › The seamless flange face eliminates the need for separate gaskets to facilitate installation in flat face flanges
 - › Multiple flange configurations available:
 - ASME B16.5/B16.47 Series A Class 125/150 (standard)
 - ASME B16.5/B16.47 Series A Class 250/300
 - EN 1092-1 PN10
 - EN 1092-1 PN16
 - Other configurations available upon request

NOTE: To achieve an effective seal, flanged designs must be installed with retaining rings, sleeve designs installed with clamping rings. The overall length of the sleeve should include an additional 4 inches (101.6mm) for clamping space.

PRESSURE RATING

- » Without external reinforcing rings: up to 3 psi (0.2 bar)
- » With external reinforcing rings: up to 15 psi (1.0 bar)

VACUUM RATING

- » Without internal reinforcing rings: up to 3 inches (75 mm) Hg
- » With internal reinforcing rings: up to 15 inches (381 mm) Hg

Contact Garlock if higher vacuum or pressure ratings are required.

MOVEMENT CAPABILITIES PER CONVOLUTION

NOMINAL ID		COMPRESSION		ELONGATION		LATERAL	
		inch	mm	inch	mm	inch	mm
2 - 6	50 - 150	3/4	19	5/8	16	5/8	16
8 - 10	200 - 250	7/8	22	3/4	19	3/4	19
12 - 18	300 - 450	1-1/8	28	1	25	1	25
20 - 48	500 - 1200	1-5/8	41	1-1/4	31	1-1/4	31

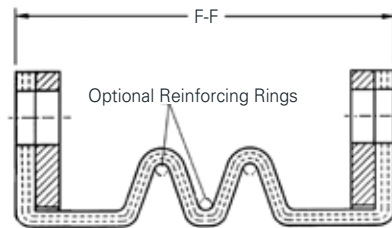

Cross Section of Style 9394 w/ optional Reinforcing Rings

TEMPERATURE - UP TO 400°F (205°C)

- » Max temperature is based on the lowest temperature of the material selected.

STANDARD FACE TO FACE

NUMBER OF CONVOLUTIONS	MIN. F - F	
	inch	mm
1	4.5	114
2	6	152
3	7.5	191
4	9	229

MATERIALS OF CONSTRUCTION

See pages 4 - 6 for tube and cover material options.

OPTIONAL CONFIGURATIONS

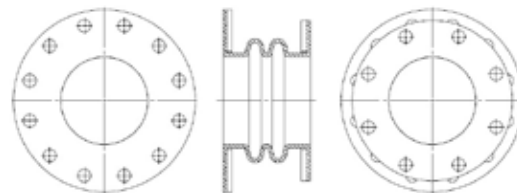

Unique Drill Patterns per flange

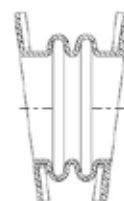

Angular Offset

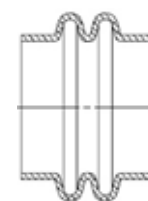

Sleeve Connection

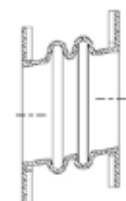

Lateral Offset

Style 8400

Garlock offers a wide range of duct type expansion joints for lightweight applications, especially for scrubbers, precipitators, bag houses, and fans in air handling systems. Style 8400 expansion joints are available in round, rectangular or square configurations, as belt type (without flanges) or U-type (flanged), with virtually no size restrictions.

RECTANGULAR / SQUARE

- » Face-to-face dimensions: typically 6" (152 mm), 9" (229 mm) or 12" (305 mm)
- » If any side is smaller than 24" (600 mm), joint will be built on a metal form with column corners

NOTE: Other sizes also available. If more movement is required, please contact Garlock.

ROUND

- » Supplied in any size, with or without flanges or arch
- » Movement capabilities depend on expansion joint size and arch configuration

BELT TYPE

- » Supplied in any size, without flanges, with or without an arch
- » Available in the same materials as Style 8400 round expansion joints
- » Movement capabilities depend on installation width and arch configuration
- » Supplied open-ended (wraparound), or continuous to fit over ducting

TEMPERATURE - UP TO 400°F (205°C)

Max temperature is based on the lowest temperature of the material selected.

PRESSURE RATING - 3psi (.2 bar)

VACUUM RATING - 6 In. Hg. (152 mm Hg.)

MATERIALS OF CONSTRUCTION

See pages 4 - 6 for tube and cover material options.

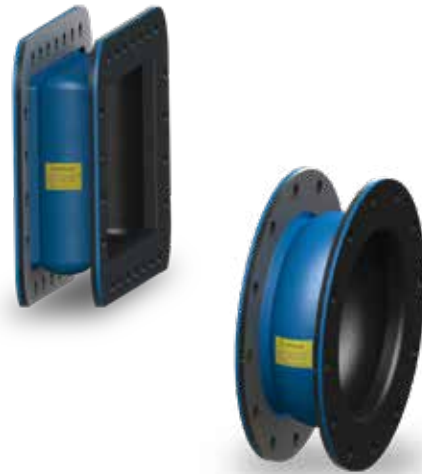

MOVEMENT CHART - NO ARCH

ID/Face to Face	Max. Compression		Max. Elongation		Max. Lateral	
	inch	mm	inch	mm	inch	mm
All sizes	1/4	6	1/4	6	1/4	6



MOVEMENT CHART - EZ-FLO™ ARCH

ID		Max. Compression		Max. Elongation		Max. Lateral	
inch	mm	inch	mm	inch	mm	inch	mm
1"-5"	25-125	0.75	19	0.375	10	0.5	13
6"-18"	150-450	1	25	0.5	13	0.5	13
20"-24"	500-600	1.125	29	0.5	13	0.5	13
26"-40"	650-1000	1.25	32	0.5	13	0.5	13
42"-120"	1050-3000	1.375	35	0.5	13	0.5	13



MOVEMENT CHART - FLOWING ARCH

F - F		Max. Compression		Max. Elongation		Max. Lateral	
inch	mm	inch	mm	inch	mm	inch	mm
6	150	1½	38	½	13	±1	25
9	225	3	76	1	25	±2	50
12	300	4	100	1	25	±2½	63
16	400	6	150	1	25	±3½	89

NOTE: Available with 3" wide flanges only and 24" minimum ID

Style 8420 Split

Easy installation and removal

- » Split design eliminates equipment disassembly, reducing costly downtime.
- » Available in EPDM, Nitrile* and Fluoroelastomer in sizes from 2" to 24" standard. Contact Garlock for larger sizes.
- » Can be customized for your application; contact Garlock with your specifications.

* EPDM and nitrile are standard - other elastomers available on request.

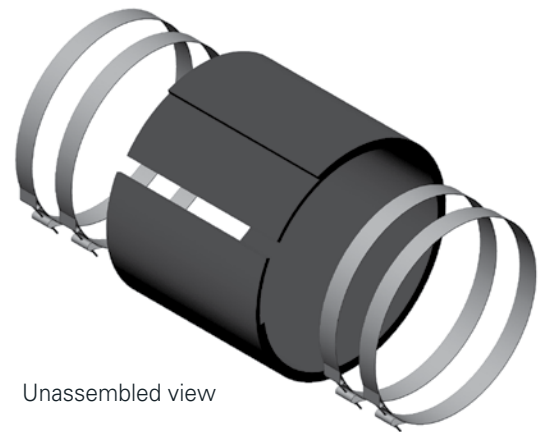

Unassembled view

SPECIFICATIONS

	2" Max. Pipe Gap Opening	4" Max. Pipe Gap Opening	6" Max. Pipe Gap Opening
Clamps Required:	4	4	4
Thickness:			
2"-12" Size (50.8mm-304.8mm)	1/4" (6.4mm)	1/4" (6.4mm)	1/4" (6.4mm)
14"-24" Size (355.6mm-609.6mm)	3/8" (9.5mm)	3/8" (9.5mm)	3/8" (9.5mm)
Pressure, Max:	15psi (1.043 bar)	5psi (0.345 bar)	5psi (0.345 bar)
Vacuum:	14" Hg (356mm Hg)	5" Hg (127mm Hg)	5" Hg (127mm Hg)
Temperature, Max.			
with standard adhesive kit	165°F (74°C)	165°F (74°C)	165°F (74°C)
with Viton* adhesive	400°F (204°C)	400°F (204°C)	400°F (204°C)
Movement:	Vibration Only	Vibration Only	Vibration Only
Lateral Misalignment, Max.:	1/2" (12.7mm)	1/2" (12.7mm)	1/2" (12.7mm)
Width of Joint:	8" (203.2mm)	10" (254mm)	12" (304.8mm)

NOTES:

1. All applications above 165°F (74°C) require Viton* adhesive kits
2. T-bolt clamps recommended on all applications. Garlock does not supply clamping hardware
3. Adhesive kits are sold separately

* Viton is a registered trademark of DuPont Dow Elastomers

Customization Capabilities

Garlock Expansion Joints are engineered, designed and manufactured in Palmyra, NY. Our team is available to help solve your unique problems. Garlock specializes in designing and manufacturing expansion joints customized to the application while providing the customer with a seamless installation.

EXPANSION JOINT DESIGN

Despite the best efforts, real world piping is never as perfect as designed on paper. Foundations settle, pumps are not installed in the exact location designed, and space is limited. Standard expansion joints are not always ideal and customized joints are the solution to real world problems. From non-standard sizes to unique flange connections, Garlock has the experience and expertise to design an expansion joint to meet your system demands.

- » Non standard ID
- » Oversized arches
- » Multiple arches
- » Vacuum support rings
- » Factory splicing
- » Oversized bolt holes
- » Non standard flanges
- » Lightweight designs
- » Non-standard shapes
- » Sealed/Painted bolt holes

ACCESSORIES DESIGN

With custom expansion joints provided by Garlock, accessories for these special products are available to ensure the full spectrum of the application needs are fulfilled. Technical experts at Garlock specialize in tailoring the following accessories:

- » Threaded bolt holes on retaining rings
- » Custom control units to accommodate offset
- » Integrating control units with retaining rings
- » Stainless steel, galvanized and uncoated material options
- » Speciality metal Flow Liners

MATERIALS

Garlock can provide the optimum materials for the specific application and is not limited to the industry standard tube and cover combinations that most manufacturers carry. Garlock Material Engineers can formulate compounds in house to meet the specific elastomer specifications required. With small batch sizes available, large lot sizes are not required.

- » Material combinations
- » Specific elastomer specifications
- » Small batch sizes



TESTING/CERTIFICATION

Garlock maintains material traceability on all materials in stock so there is not an extended wait when traceability or raw material test reports are required. 24 hour access is available for any required customer witness points and inspections at any point of the manufacturing process.

- » Materials traceability
- » Raw material test reports
- » Witness points
- » Outside inspectors
- » Accelerated life test
- » Welding certifications/testing
- » Hydrostatic/air pressure testing

OTHER CUSTOMIZATION

Contact Garlock for any specific request and our team will work to accommodate.

- » Labeling
- » Imbedded, metal, paper, and weather proof tagging
- » Packaging
- » CAD drawings
- » 3D Models

Expansion Joint Accessories

METAL RETAINING RINGS

- » Retaining rings are required for all expansion joint installations. The metal surface of the ring equally distributes the bolting pressure, preventing flange damage during bolt tightening.
- » Rings should be installed against the expansion joint's external flange.
- » Standard material of construction is mild steel with a corrosion-resistance coating; galvanized and stainless steel options available upon request.

CONTROL UNITS

- » Control units are recommended for most applications to prevent damage to the expansion joint from excessive pipe movement.
- » A control unit assembly consists of two or more tie rods connected between pipe flanges.
- » Triangular end plates (gussets) come complete with two holes for secure bolting to the flange and one hole to accommodate the connecting tie rod.
- » Spherical washers are incorporated to accommodate moderate piping misalignment and to assist with angular, torsional, and lateral movements.
- » Each rod incorporates double nuts on each end to prevent over-elongation of the expansion joint.
- » When excessive axial compression is a concern, compression nuts can be incorporated to prevent damage as a result of over-compression.
- » Please note, control units are NOT intended as a replacement for adequate pipeline anchoring.

TYPICAL CONTROL UNIT FOR RUBBER EXPANSION JOINT



METAL FLOW LINERS

- » A metallic flow liner can extend service life by protecting the expansion joint from abrasive materials or solids, particularly in high-velocity applications.
- » Flanged at one end, flow liners are installed with the flange at the head of the media flow. Designed to allow expansion joint to move freely in lateral direction without interference.
- » Liner flange thickness: 10 gauge
Liner body thickness: Under 6": 16 gauge, 6" and over: 10 gauge
- » Recommended for Flow Rates: 8 fps
- » Available in 304/316 stainless steel; also, titanium, Hastelloy C, and other materials upon request
- » Special configurations available for reducing and multi-arch designs. Please contact Garlock for additional information.

METAL FLOW LINER INSTALLATION

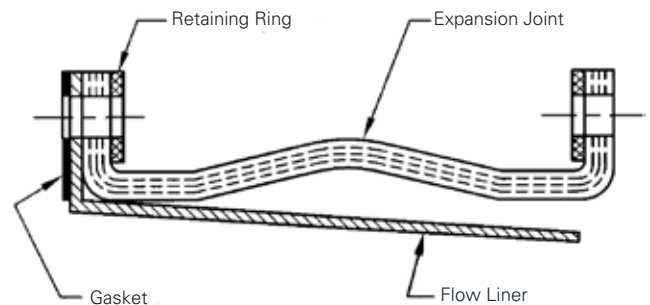

FIRE RESISTANT COVERS

Recommended on applications where flammable liquids are being used or in fire water systems.

- » Constructed from several layers of fiberglass fabric with a surface layer of silver-covered, high-temperature resistant silicone aluminum-glass fabric.
- » Tested to ISO 15540 at 1472°F (800°C) for 30 minutes for fire resistance
- » Provided as a split design to allow for easy installation and inspection.
- » The cover is oil-resistant, providing added protection against weather and aging of the expansion joint.

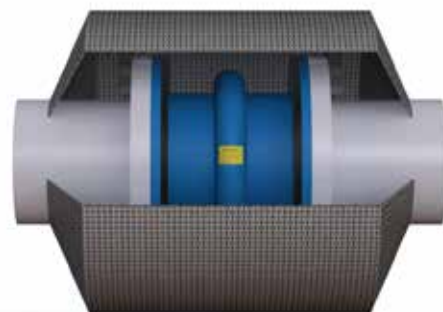

Preventative Maintenance & Reliability Service

EXPANSION JOINT INSPECTIONS

As part of a preventive maintenance (PM) program, routine expansion joint inspections serve an important role in maximizing up time and efficiency. With an ongoing decline in the availability of skilled trades, maintenance technicians and reliability engineers are assuming responsibility for more equipment and larger areas of the plant. There are simply not enough hours in the day or resources at hand to perform every PM recommended to keep a facility running. Consequently, manufacturer recommended expansion joint PM can be easily overlooked or forgotten.

Unlike most system components, rubber expansion joints exhibit obvious outward signs of deterioration. This deterioration is typically due to settling, misalignment, excessive movement, chemical incompatibility, or a combination thereof. While these characteristics may be obvious during visual inspection, it can be difficult for untrained personnel to judge the severity of the deterioration.

THE GARLOCK DIFFERENCE

Garlock understands the value PM has in meeting operational goals and offers programs designed to assist our clients with these needs. Unplanned downtime and its associated costs put undue stress and burden on everyone from purchasing and operations to maintenance and engineering. After all, the last call anyone wants to receive is one advising that a part failed over a weekend and flooded a critical area of the plant. This can be avoided!

PMR BENEFITS

Garlock's engineers and specialists will perform inspections of all rubber (non-metallic) expansion joints currently installed or in inventory. As part of the service, each expansion joint you utilize will be visually inspected, evaluated, and pertinent visual and dimensional data recorded. This comprehensive service will provide the following:

- » Manufacturer recommended periodic inspection
- » System nomenclature and expansion joint identification information
- » Recommended replacement schedule including priority ratings

This compiled data will help engineering, maintenance and purchasing personnel formulate the necessary maintenance & replacement schedules and forecast repair budgets more accurately. Our customers have found that by partnering with Garlock and implementing the PMR Service, they can realize zero

unplanned downtime related to expansion joint failure. This service, and its associated options, has proven to be a tremendous benefit to our customers.

PMR SERVICE FEATURES

INSPECTION

As part of the in-service portion of the inspection, we will obtain detailed measurements from existing pipe flanges to document and detect piping misalignment. Garlock currently offers three inspection levels to address your needs.



- » **EXPRESS:** Includes a walk down and visual inspection in the desired area(s) of the plant, as well as measurement of any expansion joints showing obvious signs of deterioration. Garlock will discuss the on-site findings with your staff during the visit and provide recommendations and a priority replacement list based on the inspection findings.
- » **ENHANCED:** Includes all Express services as well as a summary report detailing our findings and recommendations.
- » **EXPANSIVE:** Includes all Enhanced services as well as a complete listing of all expansion joints inspected with information including condition of existing products and product recommendations.

GUARANTEED FIT

Expansion joints measured by Garlock, ordered through a participating distribution partner, and installed utilizing proven installation practices as recommended by the Fluid Sealing Association are guaranteed to fit correctly. In the event of a measurement error, Garlock will expedite and replace the expansion joint free of charge.

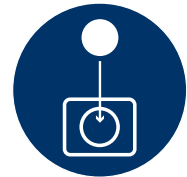

CONSOLIDATION

As part of the Preventative Maintenance & Reliability Service, Garlock surveyors can provide recommendations aimed at cost savings and inventory consolidation by identifying common size ranges or recommending general-purpose materials of construction with the intent of reducing or eliminating costly equipment specific inventory.

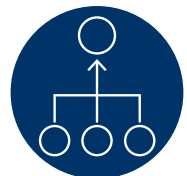





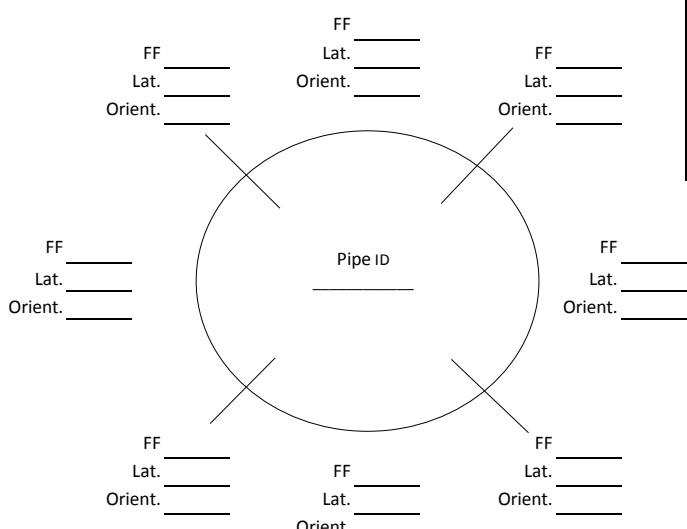

TRAINING

Garlock routinely provides Educational Training Seminars for a range of audiences including engineers, maintenance teams, and purchasing. Our most frequent requested training seminars cover topics such as expansion joint removal, visual inspections, proper bolting sequence, lifting and lugging, troubleshooting, and dimensional verification for installation and maintenance personnel. We will work with you to custom craft an agenda that meets your training needs.

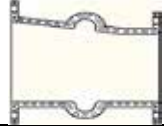

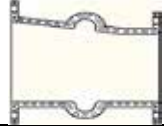
Expansion Joint Survey

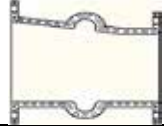
Garlock Sealing Technologies EJ Survey Sheet DC-319 05-16		Page #: _____						
Customer Name: _____ Plant Location: _____ Contacts at Plant: _____ Distributor: _____ Contact: _____ FSR: _____ Survey by: _____		Garlock Tag #: _____ Customer Location Description: _____ _____ _____ _____						
<div style="text-align: center;"><u>Measurements</u></div> View looking from _____ (stationary / front flange) to _____ (moving / back flange)		<div style="text-align: center;">Orientation Directions</div> Horizontal run Use clock positions 						
<div style="text-align: center;">  <p style="text-align: center;">Pipe ID _____</p> </div>		Evaluation: _____ _____ _____ _____ Other Notes: _____ _____ _____ _____						
<div style="text-align: center;">Vertical Run</div> Use compass 		S.T.A.M.P. Temperature: _____ Application: _____ _____ _____ _____ Media: _____ _____ _____ Pressure: _____ Vacuum: _____						
<u>Arch Information</u> Type of Arch: Abrupt Ez-Flo # of arches: _____	<u>Visual Inspection</u> <table style="width:100%; border-collapse: collapse;"> <tr> <td style="width: 20px; text-align: center;"> <input type="checkbox"/> <input type="checkbox"/> <input type="checkbox"/> <input type="checkbox"/> <input type="checkbox"/> <input type="checkbox"/> <input type="checkbox"/> <input type="checkbox"/> <input type="checkbox"/> <input type="checkbox"/> <input type="checkbox"/> </td> <td> Cracking at Base of Flange Cracking at Base of Arch Fabric Exposed and Torn Ballooning Delamination of Cover Arch Twisted O.D. of Flange Delaminated Painted Overcompressed Overelongated Bolt Interference Bolts in Backwards Soft & Spongy Leaking </td> </tr> </table>		<input type="checkbox"/> <input type="checkbox"/> <input type="checkbox"/> <input type="checkbox"/> <input type="checkbox"/> <input type="checkbox"/> <input type="checkbox"/> <input type="checkbox"/> <input type="checkbox"/> <input type="checkbox"/> <input type="checkbox"/>	Cracking at Base of Flange Cracking at Base of Arch Fabric Exposed and Torn Ballooning Delamination of Cover Arch Twisted O.D. of Flange Delaminated Painted Overcompressed Overelongated Bolt Interference Bolts in Backwards Soft & Spongy Leaking				
<input type="checkbox"/> <input type="checkbox"/> <input type="checkbox"/> <input type="checkbox"/> <input type="checkbox"/> <input type="checkbox"/> <input type="checkbox"/> <input type="checkbox"/> <input type="checkbox"/> <input type="checkbox"/> <input type="checkbox"/>	Cracking at Base of Flange Cracking at Base of Arch Fabric Exposed and Torn Ballooning Delamination of Cover Arch Twisted O.D. of Flange Delaminated Painted Overcompressed Overelongated Bolt Interference Bolts in Backwards Soft & Spongy Leaking							
<u>Retaining Ring information</u> Type of Rings: _____ Condition of Rings: _____	<u>Drilling Information</u> ANSI 150# <input type="checkbox"/> Other <input type="checkbox"/> Non-Standard Details OD _____ Dist. Between Bolts _____ # Holes _____ Hole Dia. _____							
<u>Control Unit Information</u> CU's being used: <input type="checkbox"/> Yes <input type="checkbox"/> No # Rods / Set: _____	<u>Currently Using</u> Manufacturer: _____ Style Number: _____ Description: _____ _____ _____							
<input type="checkbox"/> Vertical Pipe Run <input type="checkbox"/> Horizontal Pipe Run <input type="checkbox"/> Angular Pipe Run	<u>Tapers</u> <table style="width:100%; border-collapse: collapse;"> <tr> <td style="width: 30%;"> Concentric taper <input type="checkbox"/> </td> <td style="width: 40%; text-align: center;">  </td> <td style="width: 30%;"> The flanges on concentric tapers share a center line </td> </tr> <tr> <td> Eccentric taper <input type="checkbox"/> </td> <td style="text-align: center;">  </td> <td> Eccentric tapers have an edge that is parallel to the connecting pipe </td> </tr> </table>		Concentric taper <input type="checkbox"/>		The flanges on concentric tapers share a center line	Eccentric taper <input type="checkbox"/>		Eccentric tapers have an edge that is parallel to the connecting pipe
Concentric taper <input type="checkbox"/>		The flanges on concentric tapers share a center line						
Eccentric taper <input type="checkbox"/>		Eccentric tapers have an edge that is parallel to the connecting pipe						

Industry Specifics

FOOD & BEVERAGE

FDA Compliant to 21CFR 177.2600

- » Style 206
- » Style 204
- » Style 7250
- » Style 9394
- » Style 8400

FDA Compliant to 21CFR 177.1550

- » GUARDIAN® FEP Liners (Style 204 & Style 206)
- » SURE-LINK™ PTFE expansion joints



POTABLE WATER

NSF/ANSI/CAN-61 certified with SURE-TEC™ FDA/NSF-61 EDPM Tube

- » Style 204
- » Style 206
- » Style 7250



NUCLEAR

Garlock is the only manufacturer of nuclear safety-related elastomeric expansion joints in the United States. Garlock maintains an active nuclear quality program in accordance with 10CFR50 Appendix B and 10CFR21 for select product offerings as detailed in our Quality Manual. We have been an ISO 9001 registered company since 1994 and are regularly audited by NUPIC (Nuclear Procurement Issues Committee) audit teams. Here are a couple of our key products for the nuclear industry:

- » Style 204/204HP
- » Style 206
- » Style 8420 (204EPS)
- » Style 204EVS



Style 204HP



Style 7706



Style 8100



Style 204

MARINE

ABS TYPE APPROVAL

- » Style 204MAX
- » GAR-FLEX® Style 8100
- » Style 206
- » Style 204HP



FIRE RESISTANCE ISO 15540*

- » Style 206
- » Style 8100
- * with use of fire safe cover

U.S. NAVY

Garlock manufactures numerous expansion joints in accordance with U.S. Navy specifications. U.S. Navy specification **MIL-E-15330D** was superseded by **ASTM F-1123**. Contact the product line for information relating to other military specifications.

- » Style 206
- » Style 204 HP
- » Style 204MAX
- » Style 7706-S Type
- » GAR-FLEX® Style 8100

U.S. COAST GUARD

Garlock manufactures to applicable Code of Federal Regulations and ASTM standards. **46CFR56 series**

- » Style 206
- » Style 204HP
- » Style 204MAX
- » GAR-FLEX® Style 8100

INTERNATIONAL

Garlock has undergone design review and received provincial **Canadian Registration Number (CRN) - (all provinces)**

- » Style 204HP
- » Style 206

Types of Expansion Joints

SINGLE ARCH

- » Fabric and rubber construction
- » Reinforced with metal/wire rings
- » Full-face flanges integral with joint body

- » Flanges drilled to companion bolt pattern
- » Gaskets not required
- » Offset

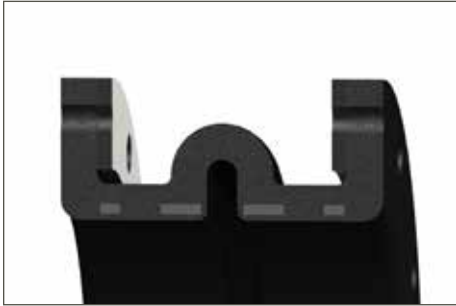

MULTIPLE ARCH

- » Accommodates greater movement than single arch
- » Minimum joint length depends on number of arches
- » Maximum of four arches recommended to maintain lateral stability

SLEEVE

- » Same as single arch type, except sleeve end I.D. equals pipe O.D.
- » Slips over straight ends of open pipe
- » Ends secured by suitable clamps
- » Recommended for low pressure service only



TAPER OR REDUCER

- » Connects piping of different diameters
- » Concentric tapered joints: same axis for both ends
- » Eccentric: axis of one end offset from other end

- » Tapers in excess of 25° are not recommended
- » Pressure ratings are based on larger I.D.
- » Available with or without arches



Types of Pipe Movement

AXIAL COMPRESSION

- » Longitudinal movement shortens face-to-face dimension along axis of expansion joint or flexible coupling
- » Pipe flanges remain perpendicular to axis

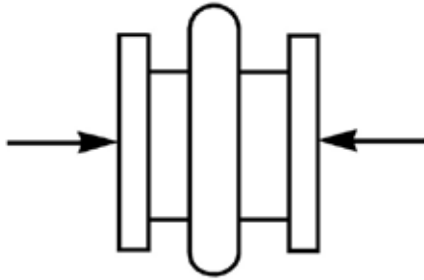

LATERAL/TRANSVERSE MOVEMENT

- » Offset movement of one or both pipe flanges
- » Both flanges remain parallel to each other while forming angle to axis of joint

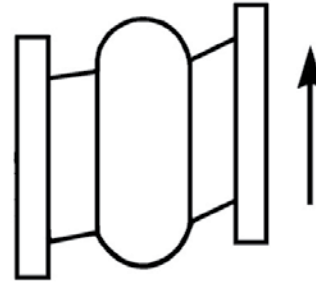

AXIAL ELONGATION

- » Longitudinal movement lengthens face-to-face dimension along axis of expansion joint or flexible coupling
- » Pipe flanges remain perpendicular to axis

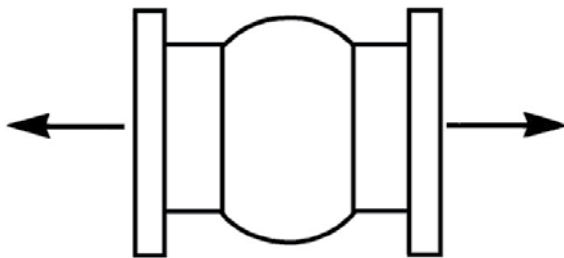

ANGULAR MOVEMENT

- » Deflection or rotation of one or both flanges
- » Forms angle with axis of expansion joint or flexible coupling

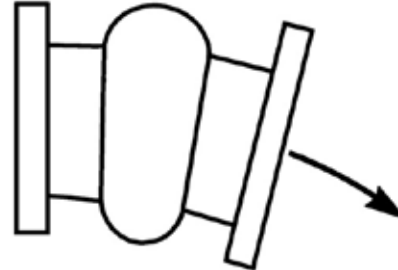

TORSIONAL MOVEMENT

- » Rotation of one flange with stationary counterpart
- » Simultaneous rotation of both flanges in opposing motion

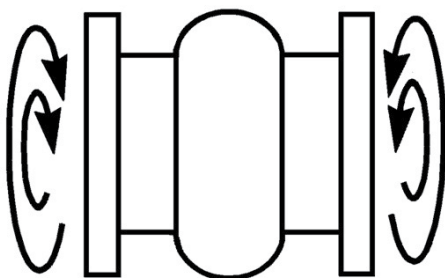

VIBRATION

- » Oscillating movement around axis of expansion joint or flexible coupling
- » Pipe flanges remain parallel with each other
- » Flanges remain perpendicular to axis
- » Mechanical vibration in steel piping system reduced with installation of pipe connectors or expansion joints



Expansion Joint Installation

PREPARATION

Check service range

- » Double check performance limits against anticipated operating conditions
- » Check temperature, pressure, vacuum recommendations
- » Check total joint deflection—alter as needed to reduce deflection to correct range
- » Anchor lines

Check location

- » Proper location is usually close to main anchoring point
- » Install pipe guide(s) for proper alignment
- » Joint should absorb pipeline expansion / contraction between fixed anchor points

Check cover

- » Check outside joint cover for damage
- » Cover will keep harmful materials from penetrating joint carcass

Check alignment

- » Alignment should be 0.125" (3.2 mm) or less
- » If 0.125" (3.2mm) must be exceeded, use a special offset joint

Check support

- » Weight must not be carried by joint
- » Support with hangers or anchors

Check flanges

- » Clean all mating flanges
- » Do not gouge or mutilate surfaces during cleaning
- » Carefully examine used parts for smoothness

INSTALLATION

Apply lubricant

- » On elastomeric joints only, not required with all PTFE- or FEP-lined joints
- » Coat rubber faces with graphite in water, or glycerine, to prevent joint adherence to pipe flanges

Insert bolts from arch side

- » On elastomeric joints only, not necessary with PTFE joints/ couplings with threaded holes
- » Set bolt heads adjacent to arch

Tighten bolts

- » Elastomeric joints only, tighten gradually and equally, alternating around flange
- » Edges of joint must bulge slightly at flange O.D.

Check tightness

- » Within one week after application, then periodically
- » In hot or cold water systems during cyclical changes

For additional information regarding expansion joint installation and maintenance please see the Installation and Maintenance Manual, EJ 9-19.

TYPICAL PIPING LAYOUT

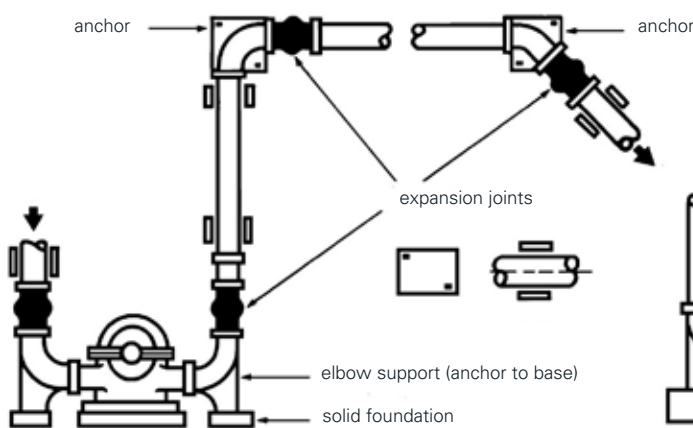

PROPER USE OF ANCHORS IN BRANCH CONNECTIONS

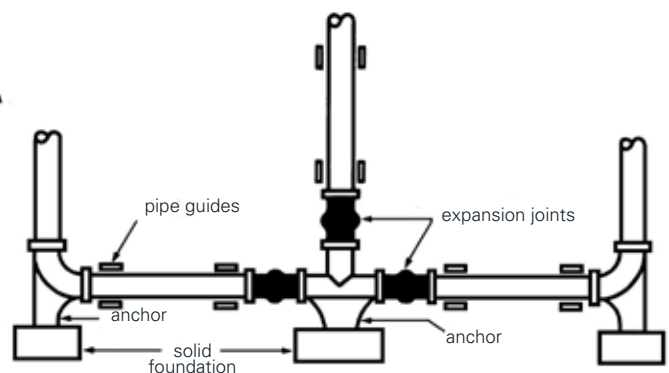

Troubleshooting

FLANGE LEAKAGE

- » Check bolt tightness
- » Check mating flange surface area for:
 - › Grooves
 - › Scratches
 - › Distorted areas
- » Over-extension may indicate need for control units

LIQUID WEeping FROM BOLT HOLES

- » Check tube portion of joint for leaks; replace if necessary

CRACKING AT BASE OF ARCH OR FLANGE

- » Check installed face-to-face dimensions for over-extension or over-compression
- » Check for proper pipe alignment: must not exceed 0.125" (3.2mm)

EXCESSIVE BALLOONING OF ARCH

- » Indicates distortion/deterioration of joint strengthening members, or excessive system pressure
- » Re-evaluate service conditions
- » Install new joint

General Precautions

ELASTOMERIC JOINTS ONLY

- » Use proper care breaking seal
- » Drive flanges apart gently with wooden wedges
- » Bring insulation only to pipe flange—do not insulate over or around joint
 - › Covering joints may make leak detection difficult
 - › Insulation could restrict joint movement or cause overheating
- » Store in cool, dry, dark area
- » Do not rest on flange edges
- » Carefully protect joints near welding operations
- » Never install spool-type joints next to flangeless check valves or butterfly valves
- » Install only against full-face metal flanges or damage/leakage could result; restrictions also apply to raised face or any non-full face flange



WARNING:

Properties/applications shown throughout this brochure are typical. Your specific application should not be undertaken without independent study and evaluation for suitability. For specific application recommendations consult Garlock. Failure to select the proper sealing products could result in property damage and/or serious personal injury.

Performance data published in this brochure has been developed from field testing, customer field reports and/or in-house testing.

While the utmost care has been used in compiling this brochure, we assume no responsibility for errors. Specifications subject to change without notice. This edition cancels all previous issues. Subject to change without notice.

GARLOCK is a registered trademark for packings, seals, gaskets, and other products of Garlock.

Expansion Joint Weights*

FOR RUBBER SPOOL-TYPE JOINTS AND STYLE 204

Joint Size (Inches)	Approx. lbs per Joint				Approx. lbs / set	
	Face-to-Face Dimension				Retaining Rings	Control Units
	6 inches	8 inches	10 inches	12 inches		
2	3.5	4.0	-	-	3.5	5.5
2½	4.0	5.0	-	-	5.0	6.5
3	4.5	5.5	-	-	5.5	6.5
3½	5.5	6.6	-	-	6.5	6.5
4	6.5	7.8	-	-	6.8	5.5
5	7.5	9.5	-	-	7.5	10.5
6	8.8	11.5	13.8	15.5	8.8	10.5
8	12.5	15.0	20.0	22.0	12.5	10.5
10	16.0	23.5	25.0	28.0	15.8	22
12	-	28.8	35.0	41.5	23.5	22
14	-	38.0	45.0	53.0	25.5	29
16	-	48.0	52.0	60.0	31.0	29
18	-	50.0	55.0	68.0	29.5	29
20	-	55.0	67.0	78.0	36.0	26
24	-	-	77.0	91.0	46.0	33
26	-	-	92.0	110.0	50.0	52
28	-	-	110.0	120.0	60.0	52
30	-	-	118.0	130.0	63.0	58
34	-	-	128.0	140.0	82.0	76
36	-	-	140.0	152.0	85.0	76
42	-	-	-	222.0	113.0	115
48	-	-	-	252.0	138.0	150
54	-	-	-	275.0	157.0	162
60	-	-	-	337.0	180.0	298
72	-	-	-	365.0	260.0	361
78	-	-	-	405.0	280.0	301
84	-	-	-	430.0	320.0	393



*For total approximate weights, add the weight of the expansion joint at the required face-to-face dimension to the weight of retaining rings and/or control units.

Example (Metric):

A 100 mm joint (200 mm face-to-face) with retaining rings equals 3.5 Kg. + 3.1 Kg., or 6.6 Kg. A 350 joint (250 mm face-to-face) with retaining rings and control units equals 20.4 Kg. + 11.6 Kg. + 12.2 Kg., or 44.2 Kg.

To convert pounds to kilograms, divide by 2.205.

Note: For calculating weight of Style 206 EZ-FLO® expansion joint = Style 204 x 0.66.

FOR PTFE COUPLINGS WITH FLANGES & RESTRICTING BOLTS

	Pipe Size (Inches)								
	1	1½	2	2½	3	4	5	6	8
SURE-LINK™ 2 convolutions	2 lbs.	4 lbs.	7 lbs.	10 lbs.	12 lbs.	18 lbs.	24 lbs.	29 lbs.	47 lbs.
SURE-LINK™ 3 convolutions	2 lbs.	4 lbs.	8 lbs.	11 lbs.	13 lbs.	19 lbs.	25 lbs.	30 lbs.	47 lbs.

Application Data Form

For quotation or application recommendations, simply copy this page, fill it out entirely and mail or fax it to Garlock or to your local authorized distributor.

Name: _____	Date: _____
Phone No.: _____	Company: _____
	Fax No.: _____
Pipe Size: _____	Control Units?: _____
Temperature: _____	Hydrostatic Testing?: _____
Pressure/Vacuum: _____	Replacement?: For What Style?: _____
Media: _____	Comments: _____
Movements - Compression: _____	_____
Elongation: _____	_____
Lateral: _____	_____
Face-to-Face Dimension: _____	_____
Drilling (if other than 125/150lb.): _____	_____
Retaining Rings: _____	_____

Drilling Charts

ASME B16.5/B16.47 CLASS 125/150 SERIES A

Nominal Pipe Inside Diameter (ID) inch	Outside Diameter (OD) inch	Bolt Circle (BC) inch	Bolt Holes (BH)	Hole Diameter inch
1	4 1/4	3 1/8	4	5/8
1 1/4	4 5/8	3 1/2	4	5/8
1 1/2	5	3 7/8	4	5/8
2	6	4 3/4	4	3/4
2 1/2	7	5 1/2	4	3/4
3	7 1/2	6	4	3/4
3 1/2	8 1/2	7	8	3/4
4	9	7 1/2	8	3/4
5	10	8 1/2	8	7/8
6	11	9 1/2	8	7/8
8	13 1/2	11 3/4	8	7/8
10	16	14 1/4	12	1
12	19	17	12	1
14	21	18 3/4	12	1 1/8
16	23 1/2	21 1/4	16	1 1/8
18	25	22 3/4	16	1 1/4
20	27 1/2	25	20	1 1/4
22	29 1/2	27 1/4	20	1 3/8
24	32	29 1/2	20	1 3/8
26	34 1/4	31 3/4	24	1 3/8
28	36 1/2	34	28	1 3/8
30	38 3/4	36	28	1 3/8
32	41 3/4	38 1/2	28	1 5/8
34	43 3/4	40 1/2	32	1 5/8
36	46	42 3/4	32	1 5/8
38	48 3/4	45 1/4	32	1 5/8
40	50 3/4	47 1/4	36	1 5/8

Nominal Pipe Inside Diameter (ID) inch	Outside Diameter (OD) inch	Bolt Circle (BC) inch	Bolt Holes (BH)	Hole Diameter inch
42	53	49 1/2	36	1 5/8
48	59 1/2	56	44	1 5/8
50	61 3/4	58 1/4	44	1 7/8
52	64	60 1/2	44	1 7/8
54	66 1/4	62 3/4	44	2
60	73	69 1/4	52	2
66	80	76	52	2
68	82 1/4	78 1/4	56	2
72	86 1/2	82 1/2	60	2
74	88 1/2	84 1/2	60	2
76	90 3/4	86 1/2	60	2
78	93	89	64	2 1/8
80	95 1/4	91	60	2 1/8
82	97 1/2	93 1/4	60	2 1/8
84	99 3/4	95 1/2	64	2 1/4
86	102	97 3/4	64	2 1/8
88	104 1/4	100	68	2 1/8
90	106 1/2	102	68	2 3/8
92	108 3/4	104 1/2	68	2 1/4
94	111	106 1/4	68	2 1/4
96	113 1/4	108 1/2	68	2 1/2
98	115 1/2	110 3/4	68	2 3/8
100	117 3/4	113	68	2 3/8
102	120	114 1/2	72	2 1/4
108	126 3/4	120 3/4	72	2 1/2
120	140 1/4	132 3/4	76	2 1/2

ASME B16.5/B16.47 CLASS 250/300 SERIES A

Nominal Pipe Inside Diameter (ID) inch	Outside Diameter (OD) inch	Bolt Circle (BC) inch	Bolt Holes (BH)	Hole Diameter inch
1	4 7/8	3 1/2	4	3/4
1 1/4	5 1/4	3 7/8	4	3/4
1 1/2	6 1/8	4 1/2	4	7/8
2	6 1/2	5	8	3/4
2 1/2	7 1/2	5 7/8	8	7/8
3	8 1/4	6 5/8	8	7/8
3 1/2	9	7 1/4	8	7/8
4	10	7 7/8	8	7/8
5	11	9 1/4	8	7/8
6	12 1/2	10 5/8	12	7/8
8	15	13	12	1
10	17 1/2	15 1/4	16	1 1/8
12	20 1/2	17 3/4	16	1 1/4
14	23	20 1/4	20	1 1/4

Nominal Pipe Inside Diameter (ID) inch	Outside Diameter (OD) inch	Bolt Circle (BC) inch	Bolt Holes (BH)	Hole Diameter inch
16	25 1/2	22 1/2	20	1 3/8
18	28	24 3/4	24	1 3/8
20	30 1/2	27	24	1 3/8
22	33	29 1/4	24	1 5/8
24	36	32	24	1 5/8
26	38 1/4	34 1/2	28	1 3/4
28	40 3/4	37	28	1 3/4
30	43	39 1/4	28	1.875
32	45 1/4	41 1/2	28	2
34	47 1/2	43 1/2	28	2
36	50	46	32	2.125
40	48 3/4	45 1/2	32	1 3/4
42	50 3/4	47 1/2	32	1 3/4
48	57 3/4	54	32	2
50	60 1/4	56 1/4	32	2 1/8
54	65 1/4	61	28	2 3/8
60	71 1/4	67	32	2 3/8

Drilling Charts

EN 1092-1 PN10

Nominal Pipe Inside Diameter (ID) inch	Outside Diameter (OD) inch	Bolt Circle (BC) inch	Bolt Holes (BH)	Hole Diameter mm
1	4.5	3.375	4	0.5625
1 1/4	5 1/2	3 15/16	4	3/4
1 1/2	5 7/8	4 5/16	4	3/4
2	6 1/2	4 15/16	4	3/4
2 1/2	7 5/16	5 11/16	4	3/4
3	7 7/8	6 5/16	8	3/4
4	8 11/16	7 1/16	8	3/4
5	9 13/16	8 1/4	8	3/4
6	11 1/4	9 7/16	8	7/8
8	13 3/8	11 5/8	8	7/8
10	15 9/16	13 3/4	12	7/8
12	17 1/2	15 3/4	12	7/8
14	19 7/8	18 1/8	16	7/8
16	22 1/4	20 1/4	16	1 1/16
18	24 3/16	22 1/4	20	1 1/16
20	26 3/8	24 7/16	20	1 1/16
24	30 11/16	28 9/16	20	1 3/16
28	35 1/4	33 1/16	24	1 3/16
32	39 15/16	37 3/8	24	1 5/16
36	43 7/8	41 5/16	28	1 5/16
40	48 7/16	45 11/16	28	1 7/16
48	57 5/16	54 5/16	32	1 9/16
56	65 15/16	62 5/8	36	1 11/16
64	75 3/8	71 5/8	40	1 15/16
72	83 1/4	79 1/2	44	1 15/16
80	91 9/16	87 13/16	48	1 15/16
88	100 3/8	96 1/16	52	2 3/16
96	108 11/16	104 5/16	56	2 3/16
104	116 9/16	112 3/16	60	2 3/16
112	125 3/16	120 7/8	64	2 3/16
120	134 1/16	129 1/2	68	2 7/16

EN 1092-1 PN10

Nominal Pipe Inside Diameter (ID) mm	Outside Diameter (OD) mm	Bolt Circle (BC) mm	Bolt Holes (BH)	Hole Diameter mm
25	115	85	4	14
32	140	100	4	18
40	150	110	4	18
50	165	125	4	18
65	185	145	8	18
80	200	160	8	18
100	220	180	8	18
125	250	210	8	18
150	285	240	8	22
200	340	295	8	22
250	395	350	12	22
300	445	400	12	22
350	505	460	16	22
400	565	515	16	26
450	615	565	20	26
500	670	620	20	26
600	780	725	20	30
700	895	840	24	30
800	1015	950	24	33
900	1115	1050	28	33
1000	1230	1160	28	36
1200	1455	1380	32	39
1400	1675	1590	36	42
1600	1915	1820	40	48
1800	2115	2020	44	48
2000	2325	2230	48	48
2200	2550	2440	52	56
2400	2760	2650	56	56
2600	2960	2850	60	56
2800	3180	3070	64	56
3000	3405	3290	68	62

Drilling Charts

EN 1092-1 PN16

Nominal Pipe Inside Diameter (ID) inch	Outside Diameter (OD) inch	Bolt Circle (BC) inch	Bolt Holes (BH)	Hole Diameter mm
1	4.5	3.375	4	0.5625
1 1/4	5 1/2	3 15/16	4	3/4
1 1/2	5 7/8	4 5/16	4	3/4
2	6 1/2	4 15/16	4	3/4
2 1/2	7 5/16	5 11/16	4	3/4
3	7 7/8	6 5/16	8	3/4
4	8 11/16	7 1/16	8	3/4
5	9 13/16	8 1/4	8	3/4
6	11 1/4	9 7/16	8	7/8
8	13 3/8	11 5/8	12	7/8
10	15 15/16	14	12	1 1/16
12	18 1/8	16 1/8	12	1 1/16
14	20 1/2	18 1/2	16	1 1/16
16	22 13/16	20 11/16	16	1 3/16
18	25 3/16	23 1/16	20	1 3/16
20	28 1/8	25 9/16	20	1 5/16
24	33 1/16	30 5/16	20	1 7/16
28	35 13/16	33 1/16	24	1 7/16
32	40 3/8	37 3/8	24	1 9/16
36	44 5/16	41 5/16	28	1 9/16
40	49 7/16	46 1/16	28	1 11/16
48	58 7/16	54 3/4	32	1 15/16
56	66 5/16	62 5/8	36	1 15/16
64	76	71 5/8	40	2 1/4
72	83 7/8	79 1/2	44	2 1/4
80	92 5/16	87 13/16	48	2 1/2

EN 1092-1 PN16

Nominal Pipe Inside Diameter (ID) mm	Outside Diameter (OD) mm	Bolt Circle (BC) mm	Bolt Holes (BH)	Hole Diameter mm
25	115	85	4	14
32	140	100	4	18
40	150	110	4	18
50	165	125	4	18
65	185	145	4*	18
80	200	160	8	18
100	220	180	8	18
125	250	210	8	18
150	285	240	8	22
200	340	295	12	22
250	405	355	12	26
300	460	410	12	26
350	520	470	16	26
400	580	525	16	30
450	640	585	20	30
500	715	650	20	33
600	840	770	20	36
700	910	840	24	36
800	1025	950	24	39
900	1125	1050	28	39
1000	1255	1170	28	42
1200	1485	1390	32	48
1400	1685	1590	36	48
1600	1930	1820	40	56
1800	2130	2020	44	56
2000	2345	2230	48	62

Spring Rate Table

STYLE 204 - OPEN ARCH

ID in. (DN)	F-F in. (mm)	Spring Rate lb/in (N/mm)			Angular Spring Rate in-lb/deg (N-m/deg)	Effective Area in ² (mm ²)
		Compression	Elongation	Lateral		
2 (50)	6 (152)	860 (151)	860 (151)	1000 (175)	8 (1)	16 (10118)
2.5 (65)	6 (152)	920 (161)	920 (161)	1060 (186)	13 (1)	20 (12969)
3 (80)	6 (152)	1040 (182)	1040 (182)	1120 (196)	20 (2)	24 (16173)
4 (100)	6 (152)	1100 (193)	1100 (193)	1240 (217)	38 (4)	33 (20995)
5 (125)	6 (152)	1280 (224)	1280 (224)	1400 (245)	70 (8)	44 (27907)
6 (150)	6 (152)	1360 (238)	1360 (238)	1560 (273)	107 (12)	57 (35800)
8 (200)	6 (152)	1040 (182)	1040 (182)	1700 (298)	145 (16)	95 (59915)
10 (250)	8 (203)	1200 (210)	1200 (210)	2000 (350)	262 (30)	133 (83571)
12 (300)	8 (203)	1930 (338)	1930 (338)	2300 (403)	606 (69)	177 (111155)
14 (350)	8 (203)	2200 (385)	2200 (385)	2400 (420)	941 (106)	254 (160176)
16 (400)	8 (203)	2400 (420)	2400 (420)	2800 (490)	1340 (151)	314 (197608)
18 (450)	8 (203)	2667 (467)	2667 (467)	3000 (525)	1885 (213)	380 (238967)
20 (500)	8 (203)	2514 (440)	2695 (472)	3200 (560)	2352 (266)	452 (284253)
22 (550)	10 (254)	3200 (560)	3430 (600)	3500 (613)	3622 (409)	531 (333466)
24 (600)	10 (254)	3429 (600)	3677 (643)	3700 (648)	4620 (522)	616 (386606)
26 (650)	10 (254)	3300 (578)	3539 (619)	4000 (700)	5219 (590)	731 (458794)
28 (700)	10 (254)	3400 (595)	3646 (638)	4200 (735)	6236 (705)	830 (520785)
30 (750)	10 (254)	3700 (6480)	3968 (694)	4500 (788)	7790 (880)	935 (586704)
34 (850)	10 (254)	4150 (726)	4450 (779)	4900 (858)	11223 (1268)	1164 (730322)
36 (900)	10 (254)	4350 (761)	4665 (816)	5200 (910)	13188 (1490)	1288 (808021)
40 (1000)	10 (254)	4800 (840)	5147 (901)	5700 (998)	17966 (2030)	1555 (975201)
42 (1050)	12 (305)	4444 (778)	4765 (834)	5900 (1033)		1735 (1088035)
48 (1200)	12 (305)	4978 (871)	5338 (934)	6600 (1155)		2206 (1383030)
50 (1250)	12 (305)	5333 (933)	5719 (1001)	6900 (1208)		2376 (1489216)
54 (1350)	12 (305)	5689 (996)	6100 (1068)	7400 (1295)		2734 (1713369)
60 (1500)	12 (305)	6400 (1120)	6863 (1201)	8100 (1418)		3318 (2079050)
66 (1650)	12 (305)	6933 (1213)	7434 (1301)	8800 (1540)		3959 (2480075)
72 (1800)	12 (305)	7555 (1322)	8101 (1418)	9600 (1680)		4657 (2916442)
84 (2100)	12 (305)	9333 (1633)	10008 (1751)	13200 (2310)		6221 (3895205)
96 (2400)	12 (305)	10500 (1838)	11259 (1970)	14240 (2492)		8012 (5015340)
108 (2700)	12 (305)	11422 (1999)	12248 (2143)	18800 (3290)		10029 (6276846)
120 (3000)	12 (305)	12400 (2170)	13297 (2327)	20500 (3588)		12272 (7679725)

*All spring rates should be considered approximate and are based on a zero pressure system at ambient temperatures.

NOTE: For GUARDIAN® FEP liner spring rates please contact Garlock.

Spring Rate Table

STYLE 204 - FILLED ARCH

ID in. (DN)	F-F in. (mm)	Spring Rate lb/in (N/mm)			Angular Spring Rate in-lb/deg (N-m/deg)	Effective Area in ² (mm ²)
		Compression	Elongation	Lateral		
2 (50)	6 (152)	3440 (602)	3440 (602)	4000 (700)	30 (3)	3 (1963)
2.5 (65)	6 (152)	3680 (644)	3680 (644)	4240 (742)	50 (6)	5 (3318)
3 (80)	6 (152)	4160 (728)	4160 (728)	4480 (784)	82 (9)	7 (5027)
4 (100)	6 (152)	4400 (770)	4400 (770)	4960 (868)	154 (17)	13 (7854)
5 (125)	6 (152)	5120 (896)	5120 (896)	5600 (980)	279 (32)	20 (12272)
6 (150)	6 (152)	5440 (952)	5440 (952)	6240 (1092)	427 (48)	28 (17671)
8 (200)	6 (152)	4160 (728)	4160 (728)	6800 (1190)	581 (66)	50 (31416)
10 (250)	8 (203)	4800 (840)	4800 (840)	8000 (1400)	1047 (118)	79 (49087)
12 (300)	8 (203)	7720 (1351)	7720 (1351)	9200 (1610)	2425 (274)	113 (70686)
14 (350)	8 (203)	8800 (1540)	8800 (1540)	9600 (1680)	3763 (425)	154 (96211)
16 (400)	8 (203)	9600 (1680)	9600 (1680)	11200 (1960)	5362 (606)	201 (125664)
18 (450)	8 (203)	10668 (1867)	10668 (1867)	12000 (2100)	7541 (852)	254 (159043)
20 (500)	8 (203)	10056 (1760)	10780 (1887)	12800 (2240)	9407 (1063)	314 (196350)
22 (550)	10 (254)	12800 (2240)	13720 (2401)	14000 (2450)	14487 (1637)	380 (237583)
24 (600)	10 (254)	13716 (2400)	14708 (2574)	14800 (2590)	18482 (2088)	452 (282743)
26 (650)	10 (254)	13200 (2310)	14154 (2477)	16000 (2800)	20875 (2359)	531 (331831)
28 (700)	10 (254)	13600 (2380)	14583 (2552)	16800 (2940)	24943 (2819)	616 (384845)
30 (750)	10 (254)	14800 (2590)	15870 (2777)	18000 (3150)	31161 (3521)	707 (441786)
34 (850)	10 (254)	16600 (2905)	17800 (3115)	19600 (3430)	44892 (5073)	908 (567450)
36 (900)	10 (254)	17400 (3045)	18658 (3265)	20800 (3640)	52754 (5961)	1018 (636173)
40 (1000)	10 (254)	19200 (3360)	20588 (3603)	22800 (3990)	71866 (8121)	1257 (785398)
42 (1050)	12 (305)	17776 (3111)	19061 (3336)	23600 (4130)		1385 (865901)
48 (1200)	12 (305)	19912 (3485)	21352 (3737)	26400 (4620)		1810 (1130973)
50 (1250)	12 (305)	21332 (3733)	22874 (4003)	27600 (4830)		1963 (1227185)
54 (1350)	12 (305)	22756 (3982)	24401 (4270)	29600 (5180)		2290 (1431388)
60 (1500)	12 (305)	25600 (4480)	27451 (4804)	32400 (5670)		2827 (1767146)
66 (1650)	12 (305)	27732 (4853)	29737 (5204)	35200 (6160)		3421 (2138246)
72 (1800)	12 (305)	30220 (5289)	32405 (5671)	38600 (6720)		4072 (2544690)
84 (2100)	12 (305)	37332 (6533)	40031 (7005)	52800 (9240)		5542 (3463606)
96 (2400)	12 (305)	42000 (7350)	45037 (7881)	56960 (9968)		7238 (4523893)
108 (2700)	12 (305)	45688 (7995)	48991 (8573)	75200 (13160)		9161 (5725553)
120 (3000)	12 (305)	49600 (8680)	53186 (9308)	82000 (14350)		11310 (7068583)

*All spring rates should be considered approximate and are based on a zero pressure system at ambient temperatures.

Spring Rate Table

STYLE 204HP - OPEN ARCH

ID in. (DN)	F-F in. (mm)	Spring Rate lb/in (N/mm)			Angular Spring Rate in-lb/deg (N-m/deg)	Effective Area in ² (mm ²)
		Compression	Elongation	Lateral		
2 (50)	6 (152)	989 (173)	989 (173)	1150 (201)	9 (1)	16 (10118)
2.5 (65)	6 (152)	1058 (185)	1058 (185)	1219 (213)	14 (2)	20 (12969)
3 (80)	6 (152)	1196 (209)	1196 (209)	1288 (225)	23 (3)	24 (16173)
4 (100)	6 (152)	1265 (221)	1265 (221)	1426 (250)	44 (5)	33 (20995)
5 (125)	6 (152)	1472 (258)	1472 (258)	1610 (282)	80 (9)	44 (27907)
6 (150)	6 (152)	1564 (274)	1564 (274)	1794 (314)	123 (14)	57 (35800)
8 (200)	6 (152)	1196 (209)	1196 (209)	1955 (342)	167 (19)	95 (59915)
10 (250)	8 (203)	1380 (242)	1380 (242)	2300 (403)	301 (34)	133 (83571)
12 (300)	8 (203)	2220 (388)	2220 (388)	2645 (463)	697 (79)	177 (111155)
14 (350)	8 (203)	2530 (443)	2530 (443)	2760 (483)	1082 (122)	254 (160176)
16 (400)	8 (203)	2760 (483)	2760 (483)	3220 (564)	1541 (174)	314 (197608)
18 (450)	8 (203)	3067 (537)	3067 (537)	3450 (604)	2168 (245)	380 (238967)
20 (500)	8 (203)	2891 (506)	3099 (542)	3680 (644)	2704 (306)	452 (284253)
22 (550)	10 (254)	3680 (644)	3945 (690)	4025 (704)	4165 (471)	531 (333466)
24 (600)	10 (254)	3943 (690)	4228 (740)	4255 (745)	5313 (600)	616 (386606)
26 (650)	10 (254)	3795 (664)	4069 (712)	4600 (805)	6001 (678)	731 (458794)
28 (700)	10 (254)	3910 (684)	4193 (734)	4830 (845)	7171 (810)	830 (520785)
30 (750)	10 (254)	4255 (745)	4563 (798)	5175 (906)	8958 (1012)	935 (586704)
34 (850)	10 (254)	4773 (835)	5118 (896)	5635 (986)	12906 (1458)	1164 (730322)
36 (900)	10 (254)	5003 (875)	5364 (939)	5980 (1047)	15167 (1714)	1288 (808021)
40 (1000)	10 (254)	5520 (966)	5919 (1036)	6555 (1147)	20661 (2335)	1555 (975201)
42 (1050)	12 (305)	5111 (894)	5480 (959)	6785 (1187)		1735 (1088035)
48 (1200)	12 (305)	5725 (1002)	6139 (1074)	7590 (1328)		2206 (1383030)
50 (1250)	12 (305)	6133 (1073)	6576 (1151)	7935 (1389)		2376 (1489216)
54 (1350)	12 (305)	6542 (1145)	7015 (1228)	8510 (1489)		2734 (1713369)
60 (1500)	12 (305)	7360 (1288)	7892 (1381)	9315 (1630)		3318 (2079050)
66 (1650)	12 (305)	7973 (1395)	8549 (1496)	10120 (1771)		3959 (2480075)
72 (1800)	12 (305)	8688 (1520)	9316 (1630)	11040 (1932)		4657 (2916442)
84 (2100)	12 (305)	10733 (1878)	11509 (2014)	15180 (2657)		6221 (3895205)
96 (2400)	12 (305)	12075 (2113)	12948 (2266)	16376 (2866)		8012 (5015340)
108 (2700)	12 (305)	13135 (2299)	14085 (2465)	21620 (3784)		10029 (6276846)
120 (3000)	12 (305)	14260 (2496)	15291 (2676)	23575 (4126)		12272 (7679725)

*All spring rates should be considered approximate and are based on a zero pressure system at ambient temperatures.

Spring Rate Table

STYLE 204HP - FILLED ARCH

ID in. (DN)	F-F in. (mm)	Spring Rate lb/in (N/mm)			Angular Spring Rate in-lb/deg (N-m/deg)	Effective Area in ² (mm ²)
		Compression	Elongation	Lateral		
2 (50)	6 (152)	3956 (692)	3956 (692)	4600 (805)	35 (4)	3 (1963)
2.5 (65)	6 (152)	4232 (741)	4232 (741)	4876 (853)	646 (73)	5 (3318)
3 (80)	6 (152)	4784 (837)	4784 (837)	5152 (902)	939 (106)	7 (5027)
4 (100)	6 (152)	5060 (886)	5060 (886)	5704 (998)	1590 (180)	13 (7854)
5 (125)	6 (152)	5888 (1030)	5888 (1030)	6440 (1127)	2569 (290)	20 (12272)
6 (150)	6 (152)	6256 (1095)	6256 (1095)	7176 (1256)	3603 (407)	28 (17671)
8 (200)	6 (152)	4784 (837)	4784 (837)	7820 (1369)	4509 (509)	50 (31416)
10 (250)	8 (203)	5520 (966)	5520 (966)	9200 (1610)	7707 (871)	79 (49087)
12 (300)	8 (203)	8878 (1554)	8878 (1554)	10580 (1852)	17664 (1996)	113 (70686)
14 (350)	8 (203)	10120 (1771)	10120 (1771)	11040 (1932)	25964 (2934)	154 (96211)
16 (400)	8 (203)	11040 (1932)	11040 (1932)	12880 (2254)	36224 (4093)	201 (125664)
18 (450)	8 (203)	12268 (2147)	12268 (2147)	13800 (2415)	48177 (5444)	254 (159043)
20 (500)	8 (203)	11564 (2024)	12397 (2169)	14720 (2576)	59501 (6724)	314 (196350)
22 (550)	10 (254)	14720 (2576)	15778 (2761)	16100 (2818)	89359 (10098)	380 (237583)
24 (600)	10 (254)	15773 (2760)	16914 (2960)	17020 (2979)	113357 (12809)	452 (282743)
26 (650)	10 (254)	15180 (2657)	16278 (2849)	18400 (3220)	137573 (15546)	531 (331831)
28 (700)	10 (254)	15640 (2737)	16771 (2935)	19320 (3381)	149573 (16902)	616 (384845)
30 (750)	10 (254)	17020 (2979)	18251 (3194)	20700 (3623)	185146 (20921)	707 (441786)
34 (850)	10 (254)	19090 (3341)	20470 (3582)	22540 (3945)	265720 (30026)	908 (567450)
36 (900)	10 (254)	20010 (3502)	21457 (3755)	23920 (4186)	310077 (35039)	1018 (636173)
40 (1000)	10 (254)	22080 (3864)	23676 (4143)	26220 (4589)	419428 (47395)	1257 (785398)
42 (1050)	12 (305)	20442 (3577)	21920 (3836)	27140 (4750)		1385 (865901)
48 (1200)	12 (305)	22899 (4007)	24554 (4297)	30360 (5313)		1810 (1130973)
50 (1250)	12 (305)	24532 (4293)	26305 (4603)	31740 (5555)		1963 (1227185)
54 (1350)	12 (305)	26169 (4580)	28061 (4911)	34040 (5957)		2290 (1431388)
60 (1500)	12 (305)	29440 (5152)	31569 (5524)	37260 (6521)		2827 (1767146)
66 (1650)	12 (305)	31892 (5581)	34198 (5985)	40480 (7084)		3421 (2138246)
72 (1800)	12 (305)	34753 (6082)	37266 (6521)	44160 (7728)		4072 (2544690)
84 (2100)	12 (305)	42932 (7513)	46036 (8056)	60720 (10626)		5542 (3463606)
96 (2400)	12 (305)	48300 (8453)	51792 (9064)	65504 (11463)		7238 (4523893)
108 (2700)	12 (305)	52541 (9195)	56340 (9859)	86480 (15134)		9161 (5725553)
120 (3000)	12 (305)	57040 (9982)	61164 (10704)	94300 (16503)		11310 (7068583)

*All spring rates should be considered approximate and are based on a zero pressure system at ambient temperatures.

Spring Rate Table

STYLE 206 EZ-FLO® ARCH

ID in. (DN)	F-F in. (mm)	Spring Rate lb/in (N/mm)			Angular Spring Rate in-lb/deg (N-m/deg)	Effective Area in ² (mm ²)
		Compression	Elongation	Lateral		
2 (50)	6 (152)	610 (107)	650 (114)	620 (109)	6 (1)	8 (5249)
2.5 (65)	6 (152)	630 (110)	665 (116)	615 (108)	9 (1)	11 (7352)
3 (80)	6 (152)	720 (126)	750 (131)	710 (124)	15 (2)	14 (9808)
4 (100)	6 (152)	765 (134)	870 (152)	825 (144)	30 (3)	22 (13633)
5 (125)	6 (152)	925 (162)	980 (172)	950 (166)	53 (6)	31 (19298)
6 (150)	6 (152)	1150 (201)	1265 (221)	1180 (207)	99 (11)	41 (25944)
8 (200)	6 (152)	1270 (222)	1380 (242)	1230 (215)	193 (22)	67 (42182)
10 (250)	8 (203)	1590 (278)	1725 (302)	1540 (270)	376 (43)	104 (65189)
12 (300)	8 (203)	1910 (334)	2070 (362)	1850 (324)	650 (73)	143 (89780)
14 (350)	8 (203)	1970 (345)	2050 (359)	1890 (331)	877 (99)	189 (118298)
16 (400)	8 (203)	2050 (359)	2160 (378)	1950 (341)	1206 (136)	241 (150743)
18 (450)	8 (203)	2150 (376)	2375 (416)	2210 (387)	1679 (190)	299 (187115)
20 (500)	8 (203)	2350 (411)	2470 (432)	2380 (417)	2155 (244)	363 (227413)
22 (550)	10 (254)	2550 (446)	2650 (464)	2575 (451)	2798 (316)	452 (283498)
24 (600)	10 (254)	2750 (481)	2830 (495)	2790 (488)	3556 (402)	531 (332648)
26 (650)	10 (254)	2900 (508)	3025 (529)	2980 (522)	4461 (504)	616 (385725)
28 (700)	10 (254)	3185 (557)	3275 (573)	3100 (543)	5601 (633)	707 (442729)
30 (750)	10 (254)	3200 (560)	3450 (604)	3120 (546)	6774 (765)	804 (503661)
34 (850)	10 (254)	3600 (630)	3845 (673)	3625 (634)	9697 (1096)	1018 (637304)
36 (900)	10 (254)	4250 (744)	4500 (788)	4300 (753)	12723 (1438)	1134 (710016)
40 (1000)	10 (254)	4380 (767)	4700 (823)	4565 (799)	16406 (1854)	1385 (867221)
42 (1050)	12 (305)	4550 (796)	4870 (852)	5050 (884)	18742 (2118)	1521 (951715)
48 (1200)	12 (305)	4870 (852)	5270 (922)	5930 (1038)	26490 (2993)	1963 (1228756)
50 (1250)	12 (305)	Contact Garlock for Engineering Evaluation				2124 (1328957)
54 (1350)	12 (305)					2463 (1541140)
60 (1500)	12 (305)					3019 (1888867)
66 (1650)	12 (305)					3632 (2271937)
72 (1800)	12 (305)					4301 (2690350)
84 (2100)	12 (305)					5809 (3633205)
96 (2400)	12 (305)					7543 (4717432)
108 (2700)	12 (305)					9503 (5943030)
120 (3000)	12 (305)					11690 (7310000)

*All spring rates should be considered approximate and are based on a zero pressure system at ambient temperatures.

GARLOCK

an *EnPro* Industries family of companies

Tel: 1-877-GARLOCK / 315.597.4811

Fax: 800.543.0598 / 315.597.3216

www.garlock.com

Garlock

GHT

Garlock Australia

Garlock de Canada, LTD

Garlock China

Garlock Singapore

Garlock Germany

Garlock India Private Limited

Garlock de Mexico, S.A. De C.V.

Garlock New Zealand

Garlock Great Britain Limited

Garlock Middle East